

DO NOT OPEN THIS TEST BOOKLET UNTIL YOU ARE ASKED TO DO SO

T.B.C. : O-FTF-J-FFA

Test Booklet Series

Serial No 028441

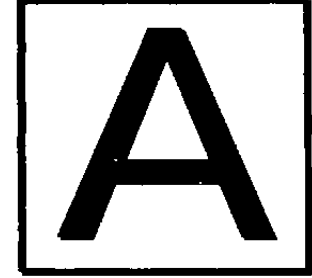

TEST BOOKLET

**ELECTRICAL ENGINEERING
Paper I**

Time Allowed : Two Hours

Maximum Marks : 200

INSTRUCTIONS

1. IMMEDIATELY AFTER THE COMMENCEMENT OF THE EXAMINATION, YOU SHOULD CHECK THAT THIS TEST BOOKLET DOES **NOT** HAVE ANY UNPRINTED OR TORN OR MISSING PAGES OR ITEMS ETC. IF SO, GET IT REPLACED BY A COMPLETE TEST BOOKLET.
2. ENCODE CLEARLY THE TEST BOOKLET SERIES A, B, C, OR D AS THE CASE MAY BE IN THE APPROPRIATE PLACE IN THE ANSWER SHEET.
3. You have to enter your Roll Number on the Test Booklet in the Box provided alongside.
DO NOT write **anything else** on the Test Booklet.
4. This Test Booklet contains **120** items (questions). Each item comprises four responses (answers). You will select the response which you want to mark on the Answer Sheet. In case you feel that there is more than one correct response, mark the response which you consider the best. In any case, choose **ONLY ONE** response for each item.
5. You have to mark all your responses **ONLY** on the separate Answer Sheet provided. See directions in the Answer Sheet.
6. All items carry equal marks.
7. Before you proceed to mark in the Answer Sheet the response to various items in the Test Booklet, you have to fill in some particulars in the Answer Sheet as per instructions sent to you with your Admission Certificate.
8. After you have completed filling in all your responses on the Answer Sheet and the examination has concluded, you should hand over to the Invigilator **only the Answer Sheet**. You are permitted to take away with you the Test Booklet.
9. Sheets for rough work are appended in the Test Booklet at the end.
10. **Penalty for wrong answers :**
THERE WILL BE PENALTY FOR WRONG ANSWERS MARKED BY A CANDIDATE IN THE OBJECTIVE TYPE QUESTION PAPERS.
 - (i) There are four alternatives for the answer to every question. For each question for which a wrong answer has been given by the candidate, **one-third (0.33)** of the marks assigned to that question will be deducted as penalty.
 - (ii) If a candidate gives more than one answer, it will be treated as a **wrong answer** even if one of the given answers happens to be correct and there will be same penalty as above to that question.
 - (iii) If a question is left blank, i.e., no answer is given by the candidate, there will be **no penalty** for that question.

DO NOT OPEN THIS TEST BOOKLET UNTIL YOU ARE ASKED TO DO SO

1. What does the expression $\frac{1}{2} \vec{J} \cdot \vec{A}$ represent ?

- (a) Power density
- (b) Radiation resistance
- (c) Magnetic energy density
- (d) Electric energy density

2. Consider the following statements :

In an n-type semiconductor

1. Fermi level lies below the donor level at room temperature (T).
2. Fermi level lies above the donor level as $T \rightarrow 0$.
3. Fermi level lies in valence band.
4. Fermi level remains invariant with temperature.

Which of the above statements is/are correct ?

- (a) 1 only
- (b) 1 and 2 only
- (c) 2, 3 and 4
- (d) 1, 2 and 3

3. $C = 0.05 \text{ F}$

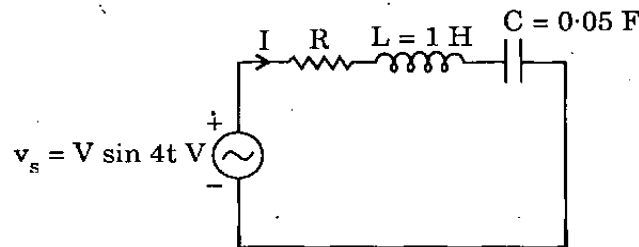

For the circuit as shown above, if the current leads the applied voltage by $\tan^{-1} 2$, what is the resistance value in ohm ?

- (a) 0.5
- (b) 1.0
- (c) 2.0
- (d) 9.5

4. The dead zone in a pyrometer is 0.125 percent of the span. The instrument is calibrated from 500°C to 2000°C . What temperature change must occur before it can be detected in degree Centigrade ?

- (a) 187.5
- (b) 1.875
- (c) 18.75
- (d) 0.1875

5.

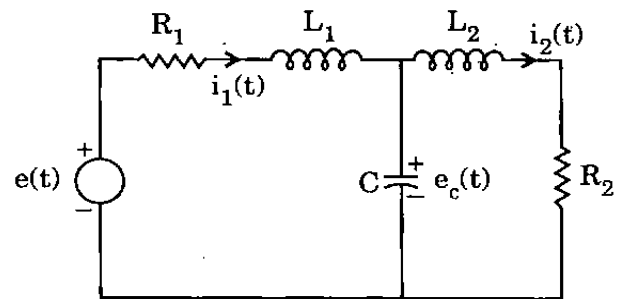

Consider the following equations with respect to the above network :

1. $L_1 \frac{di_1(t)}{dt} = R_1 i_1(t) - e_c(t) + e(t)$
2. $L_1 \frac{di_1(t)}{dt} = -R_1 i_1(t) - e_c(t) + e(t)$
3. $L_2 \frac{di_2(t)}{dt} = -R_2 i_2(t) + e_c(t)$
4. $C \frac{de_c(t)}{dt} = i_1(t) - i_2(t)$

Which of the above statements is/are correct ?

- (a) 1 only
- (b) 2, 3 and 4
- (c) 1, 3 and 4
- (d) 1, 2 and 4

6.

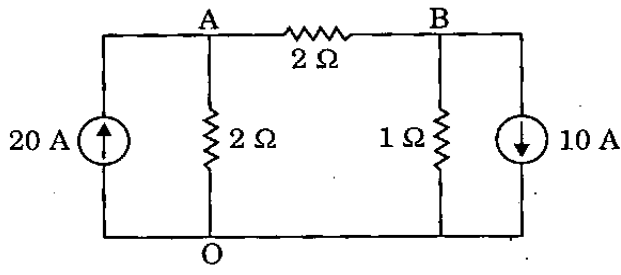

Find the voltage of the node A with respect to 'O' for the circuit as shown.

- (a) 40 V
- (b) 20 V
- (c) 50 V
- (d) 60 V

7. Match List I with List II and select the correct answer using the code given below the lists :

List I
(Type of Instrument)

- A. Indicating
- B. Absolute
- C. Recording
- D. Integrating

List II
(Example)

- 1. Wattmeter
- 2. Tangent galvanometer
- 3. Aneroid barometer
- 4. Energy meter

Code :

	A	B	C	D
(a)	1	2	3	4
(b)	4	2	3	1
(c)	1	3	2	4
(d)	4	3	2	1

8.

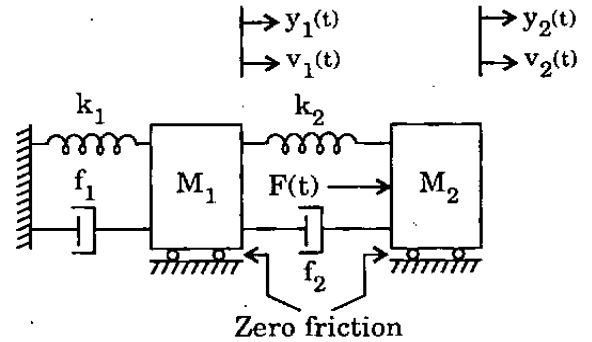

$y_1(t)$ & $y_2(t)$ are displacements

$v_1(t)$ & $v_2(t)$ are velocities.

Which one of the following is the correct free body diagram for the physical system as shown in the figure above ?

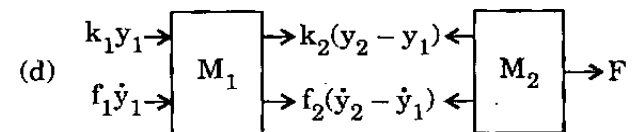
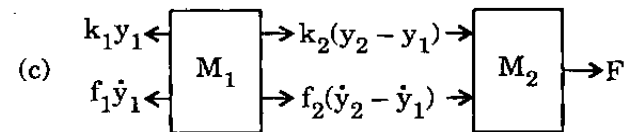
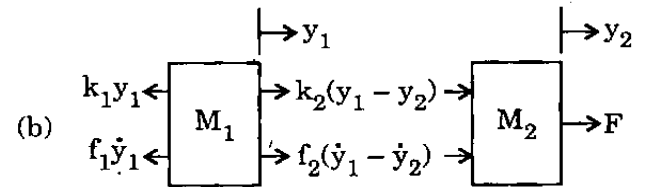
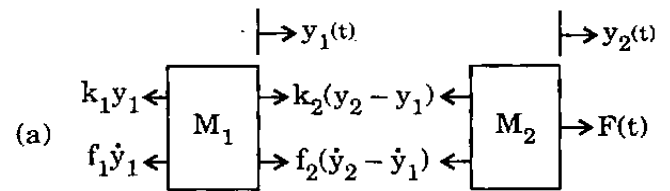

9. In a fluid flow system two fluids are mixed in appropriate proportion. The concentration at the mixing point is $y(t)$ and it is reproduced without change, T_d seconds later at the monitoring point as $b(t)$. What is the transfer function between $b(t)$ and $y(t)$? (Where S is distance between monitoring point and mixing point)

- (a) e^{-T_d}
- (b) $e^{+T_d S}$
- (c) $e^{-T_d S}$
- (d) e^{+T_d}

10. The strain gauge with a resistance of 250 ohm undergoes a change of 0.15 ohm. During a test the strain is 1.5×10^{-4} . What is the gauge factor?

- (a) 4.7
- (b) 4.0
- (c) 3.5
- (d) 2.0

11.

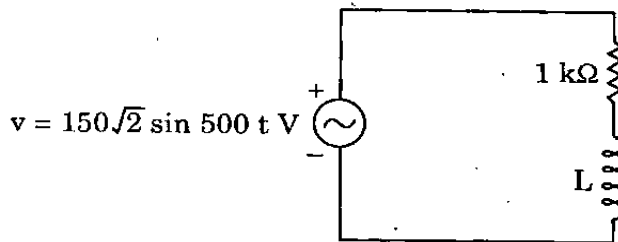

For the AC circuit as shown above, if the rms voltage across the resistor is 120 V, what is the value of the inductor?

- (a) 0.5 H
- (b) 0.6 H
- (c) 1.0 H
- (d) 1.5 H

12. Which one of the following bridges will be used for the measurement of very low resistance?

- (a) Kelvin bridge
- (b) Maxwell's bridge
- (c) Wheatstone bridge
- (d) Hay's bridge

13.

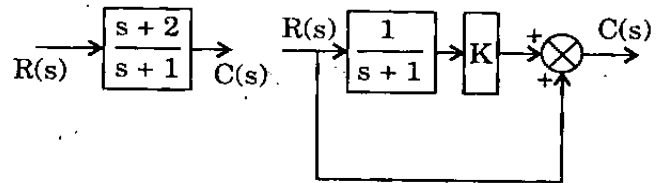

For what value of K , are the two block diagrams as shown above equivalent?

- (a) 1
- (b) 2
- (c) $(s + 1)$
- (d) $(s + 2)$

14. Consider the following :

1. Rise time
2. Settling time
3. Delay time
4. Peak time

What is the correct sequence of the time domain specifications of a second order system in the ascending order of the values?

- (a) 2 - 4 - 1 - 3
- (b) 3 - 4 - 1 - 2
- (c) 2 - 1 - 4 - 3
- (d) 3 - 1 - 4 - 2

15. The oscilloscope has an input capacitance of 50 pF and a resistance of 2 M Ω and the voltage divider ratio (k) of 10. What are the parameters of a high-impedance probe?

- (a) $C_1 = 5.55 \text{ pF}$ and $R_1 = 9 \text{ M}\Omega$
- (b) $C_1 = 5.55 \text{ pF}$ and $R_1 = 18 \text{ M}\Omega$
- (c) $C_1 = 3.33 \text{ pF}$ and $R_1 = 9 \text{ M}\Omega$
- (d) $C_1 = 1.11 \text{ pF}$ and $R_1 = 18 \text{ M}\Omega$

16. A unity feedback system with open loop transfer function of $\frac{20}{s(s+5)}$ is excited by a unit step input. How much time will be required for the response to settle within 2% of final desired value ?

- (a) 0.25 sec
- (b) 1.60 sec
- (c) 2.40 sec
- (d) 4.00 sec

17. Consider the following statements :

1. Amplifier gain and phase shift.
2. Filter transfer functions.
3. Two port network parameters.
4. Power gain in a two port circuit.

Which of the above quantities can be measured using a vector voltmeter ?

- (a) 1 and 3 only
- (b) 1, 2 and 4
- (c) 1, 2 and 3
- (d) 3 and 4

18.

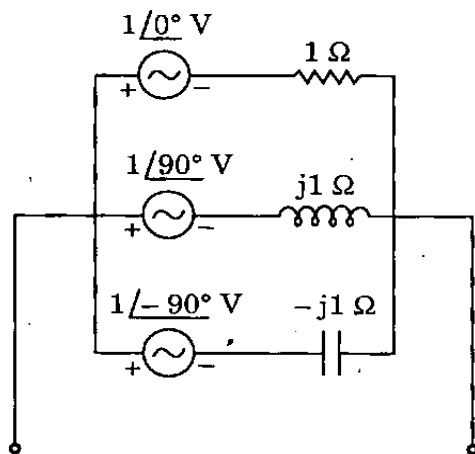

Replace the above shown circuit by a single voltage source in series with an impedance.

- (a) 2 V, 1 Ω
- (b) 1 V, 3 Ω
- (c) 3 V, 1 Ω
- (d) 2 V, 3 Ω

19. A barium titanate crystal has a thickness of 2 mm. Its voltage sensitivity is 12×10^{-3} Vm/N. It is subjected to a pressure of 0.5 MN/m². What is the voltage generated ?

- (a) 3 V
- (b) 6 V
- (c) 5 V
- (d) 12 V

20.

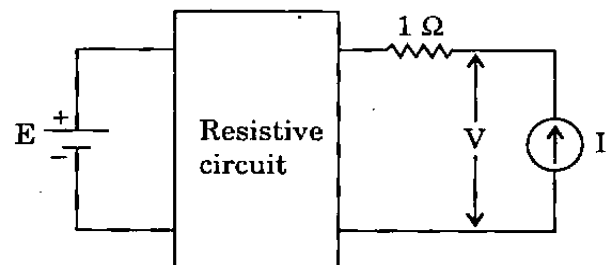

For the circuit as shown above, if $E = E_1$ and I is removed, then $V = 5$ volts. If $E = 0$ and $I = 1$ A, then $V = 5$ volts. For $E = E_1$ and I replaced by a resistor of 5Ω , what is the value of V in volts ?

- (a) 5.0
- (b) 2.5
- (c) 7.5
- (d) 3.5

21. The impulse response of a second-order under-damped system started from rest is given by :

$$C(t) = 12.5 e^{-6t} \sin 8t, \quad t \geq 0$$

What are the natural frequency and the damping factor of the system respectively ?

- (a) 10 and 0.6
- (b) 10 and 0.8
- (c) 8 and 0.6
- (d) 8 and 0.8

22. What will be the type of the system, if the steady state performance of control system yields a non-zero finite value of the velocity error constant ?

- (a) type - 0
- (b) type - 1
- (c) type - 2
- (d) type - 3

23. On which of the following factors does hysteresis loss *not* depend ?

- (a) Magnetic field intensity
- (b) Frequency of the field
- (c) Volume of the material
- (d) Neal temperature

24. A strain gauge having a resistance of 500 ohm and a gauge factor 3.0 is bonded on a member of structure undergoing tensile stress. If the change in resistance of the gauge is accurately measured as 1.5 ohm, what is the value of strain suffered by the member ?

- (a) 0.01
- (b) 0.001
- (c) 0.1
- (d) 0.003

25.

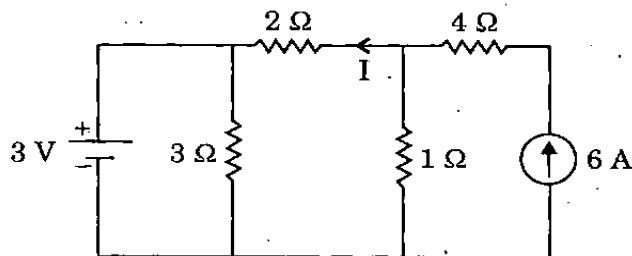

For the circuit as shown above, what is the value of I ?

- (a) 4 A
- (b) 3 A
- (c) 2 A
- (d) 1 A

26. Dissipation factor, $\tan \delta$, of a capacitor is measured by which bridge ?

- (a) Anderson bridge
- (b) Hay bridge
- (c) Schering bridge
- (d) Wien bridge

27. The characteristic equation of a feedback control system is given by :

$$s^3 + 6s^2 + 9s + 4 = 0$$

What is the number of roots in the left-half of the s-plane ?

- (a) Three
- (b) Two
- (c) One
- (d) Zero

28. Which one of the following is *not* a Maxwell's equation ?

- (a) $\nabla \times H = (\sigma + j\omega\epsilon) E$
- (b) $F = Q(E + v \times B)$
- (c) $\oint_C H \cdot ds = \int_s J \cdot ds + \int_s \frac{\partial D}{\partial t} \cdot ds$
- (d) $\oint_s B \cdot ds = 0$

29. The unit step response of a system is $[1 - e^{-t}(1+t)] u(t)$. What is the nature of the system in turn of stability ?

- (a) Unstable
- (b) Stable
- (c) Critically stable
- (d) Oscillatory

30. A D'Arsonval galvanometer, 1 mA, 50 ohm is to be converted to a 5 Amp-ammeter. What is the value of the shunt resistor, R_{sh} ?

- (a) 10 ohm
- (b) 1 ohm
- (c) 0.01 ohm
- (d) 100 ohm

31.

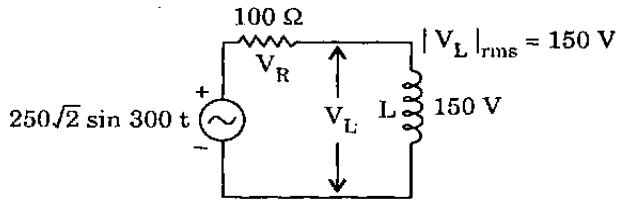

Consider the following, with respect to the circuit as shown above :

1. $V_R = 100\sqrt{2}$ V
2. $|I|_{rms} = 2$ A
3. $L = 0.25$ H

Which of the above statements is/are correct ?

- (a) 1 only
- (b) 2 and 3
- (c) 1 and 3
- (d) 1 and 2

32. Consider the following statements in connection with boundary relations of electric field :

1. In a single medium electric field is continuous.
2. The tangential components are the same on both sides of a boundary between two dielectrics.
3. The tangential electric field at the boundary of a dielectric and a current carrying conductor with finite conductivity is zero.
4. Normal component of the flux density is continuous across the charge-free boundary between two dielectrics.

Which of the above statements is/are correct ?

- (a) 1 only
- (b) 1, 2 and 3
- (c) 1, 2 and 4
- (d) 3 and 4 only

33. Consider the following :

1. Phase margin
2. Gain margin
3. Maximum overshoot
4. Bandwidth

Which of the above are the frequency domain specifications required to design a control system ?

- (a) 1 and 2 only
- (b) 1 and 3 only
- (c) 1, 3 and 4
- (d) 1, 2 and 4

34. A 0 to 300 V voltmeter has an error of $\pm 2\%$ of fsd. What is the range of readings if true voltage is 30 V ?

- (a) 24 V – 36 V
- (b) 20 V – 40 V
- (c) 29.4 V – 30.6 V
- (d) 20 V – 30 V

35. A network function $Z(s) = \frac{V(s)}{I(s)}$ has a single pole at $s = -\frac{1}{\sqrt{3}}$ and a single zero $s = -\sqrt{3}$.

If the excitation $v(t) = \sin t$, then what is the angle of lead or lag of the current ?

- (a) Lead the voltage by 30°
- (b) Lag the voltage by 30°
- (c) Lead the voltage by 90°
- (d) Lag the voltage by 90°

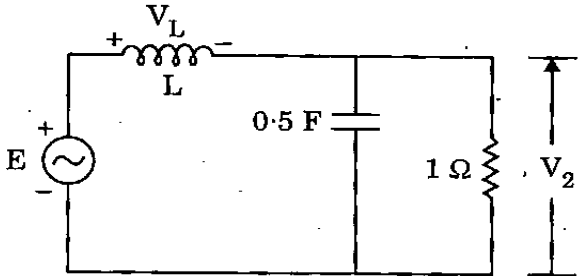
36. Magnetically hard materials do *not* possess which of the following characteristics ?
- High retentivity
 - High coercivity
 - Strong magnetic reluctance
 - Zero differential permeability
37. In a digital voltmeter, the oscillator frequency is 400 kHz. The ramp voltage falls from 8 V to 0 V in 20 ms. What is the number of pulses counted by the counter ?
- 8000
 - 4000
 - 3200
 - 1600
38. If the current flowing through a 20 ohm resistor is given as,
 $i(t) = 4 + 5 \sin \omega t - 3 \cos 3 \omega t$ amp, then what is the power consumed by the resistor ?
- 1000 W
 - 660 W
 - 500 W
 - 180 W
39. What is the error in magnitude at the corner frequency for an asymptotic Bode magnitude plot for the term $(1 + s\tau)^{\pm n}$?
- ± 20 n db
 - ± 6 n db
 - ± 3 n db
 - ± 1 n db
40. Quartz and BaTiO₃ exhibit which of the following properties ?
- Magnetostriction
 - Ferromagnetism
 - Piezoelectricity
 - Ferroelectricity
41. 
- For the above given circuit, if supply frequency, $\omega = 2$ rad/sec and $V_2 = 2 \angle 0^\circ$ volts, then what is the lead angle of V_L with V_2 ?
- 15°
 - 45°
 - 90°
 - 135°
42. A long straight wire carries a current $I = 1$ A. At what distance is the magnetic field 1 Am^{-1} ?
- 1.59 m
 - 0.159 m
 - 0.0159 m
 - 0.00159 m

43. A human nerve cell has an open circuit voltage of 80 mV and it can deliver a current of 5 nA through a 6 M ohm load. What is the maximum power available from the cell ?

- (a) 0.16 nW
- (b) 16 mW
- (c) 1.6 W
- (d) 16 pW

44. What is the slope of the line due to $\frac{1}{j\omega}$ factor in magnitude part of Bode plot ?

- (a) - 20 db per octave
- (b) - 10 db per octave
- (c) - 6 db per octave
- (d) - 2 db per octave

45. The poles and zeroes of a driving point impedance function, $z(s)$ are as

Poles 0, -2

Zeroes -1, -3

and $z(\infty) = 4$

then what is $z(s)$?

- (a) $\frac{(s^2 + 2s)}{(2s^2 + 8s + 6)}$
- (b) $\frac{(2s^2 + 4s)}{(s^2 + 4s + 3)}$
- (c) $\frac{(s^2 + 4s + 3)}{(s^2 + 2s)}$
- (d) $\frac{(4s^2 + 16s + 12)}{(s^2 + 2s)}$

46. Consider the following :

1. Human errors
2. Improper application of instruments
3. Error due to worn parts of an instrument
4. Errors due to effects of environment

Which of the above come under the type of systematic errors ?

- (a) 1 and 2
- (b) 2 and 3
- (c) 3 and 4
- (d) 1 and 4

47. Which one of the following statements is correct for the open-loop transfer function ?

$$G(s) = \frac{K(s+3)}{s(s-1)} \text{ for } K > 1$$

- (a) Open-loop system is stable but the closed-loop system is unstable.
- (b) Open-loop system is unstable but the closed-loop system is stable.
- (c) Both open-loop and closed-loop systems are unstable.
- (d) Both open-loop and closed-loop systems are stable.

48. Consider the following driving point immittance functions :

1. $z(s) = \frac{Ks(s^2+6)}{(s^2+2)(s^2+4)}$

2. $z(s) = \frac{(s^5+3s^3+5s)}{(3s^4+6s^2)}$

3. $z(s) = \frac{K(s^2+4)(s^2+9)}{(s^2+2)(s^2+6)}$

4. $z(s) = \frac{K(s^2+4)(s^2+9)}{s(s^2+6)}$

Which of these are LC immittance functions ?

- (a) 1 and 2
- (b) 3 and 4
- (c) 2 and 3
- (d) 4 only

49. For which one of the following materials, is the Hall coefficient zero ?

- (a) Insulator
- (b) Intrinsic semiconductor
- (c) Metal
- (d) Non-metal

50. Which one of the following describes correctly the effect of adding a zero to the system ?

- (a) System becomes oscillatory
- (b) Root locus shifts toward imaginary axis
- (c) Relative stability of the system increases
- (d) Operating range of K for stable operation decreases

51. What is the generalized Maxwell's equation

$$\nabla \times \bar{H} = \bar{J}e + \frac{\partial \bar{D}}{\partial t} \text{ for free space ?}$$

(a) $\nabla \times \bar{H} = 0$

(b) $\nabla \times \bar{H} = \bar{J}e$

(c) $\nabla \times \bar{H} = \frac{\partial \bar{D}}{\partial t}$

(d) $\nabla \times \bar{H} = \bar{D}$

52. Which one of the following is a frequency sensitive bridge ?

- (a) De-Sauty bridge
- (b) Schering bridge
- (c) Wien's bridge
- (d) Maxwell's bridge

53. Root locus of $s(s+2) + K(s+4) = 0$ is a circle. What are the co-ordinates of the centre of this circle ?

- (a) -2, 0
- (b) -3, 0
- (c) -4, 0
- (d) -5, 0

54. In a three-phase, balanced, delta connected system, each phase voltage contains a fundamental, a third harmonic and a fifth harmonic of RMS values : 100 V, 30 V and 20 V respectively. What is the RMS value of the line-to-line voltage ?

(a) $\sqrt{100^2 + 30^2 + 20^2}$

(b) $\sqrt{3} \times \sqrt{100^2 + 30^2 + 20^2}$

(c) $\sqrt{100^2 + 20^2}$

(d) $\sqrt{3} \times \sqrt{100^2 + 20^2}$

55. Magnetic field intensity is

$$\vec{H} = 3\vec{a}_x + 7y\vec{a}_y + 2x\vec{a}_z \text{ A/m.}$$

What is the current density \vec{J} A/m² ?

- (a) $-2\vec{a}_y$
- (b) $-7\vec{a}_z$
- (c) $3\vec{a}_x$
- (d) $12\vec{a}_y$

56. Consider the following statements :

1. Bandwidth is increased.
2. Peak overshoot in the step response is increased.

Which of these are the effects of using lead compensation in a feedback system ?

- (a) 1 only
- (b) 2 only
- (c) Both 1 and 2
- (d) Neither 1 nor 2

57. If the bandwidth of an oscilloscope is given as direct current to 10 MHz, what is the fastest rise time a sine wave can have to be produced accurately by the oscilloscope ?

- (a) 35 nsec
- (b) 10 nsec
- (c) 3.5 nsec
- (d) 0.035 nsec

58. How much current must flow in a loop of radius 1 m to produce a magnetic field of 1 mA/m⁻¹ ?

- (a) 1.0 mA
- (b) 1.5 mA
- (c) 2.0 mA
- (d) 2.5 mA

59. What is represented by state transition matrix of a system ?

- (a) Free response
- (b) Impulse response
- (c) Step response
- (d) Forced response

60.

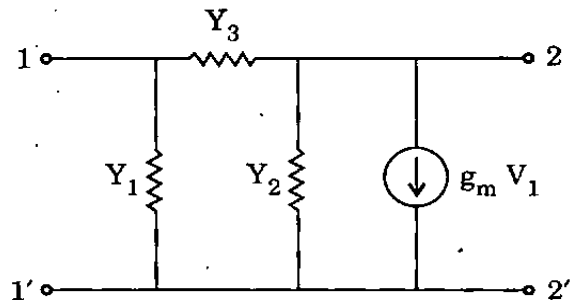

For the z-port network as shown above, what is the value of Y_{21} parameter ?

- (a) $Y_1 + Y_3$
- (b) $g_m - Y_2$
- (c) $g_m - Y_3$
- (d) $Y_1 + Y_2 + g_m$

61.

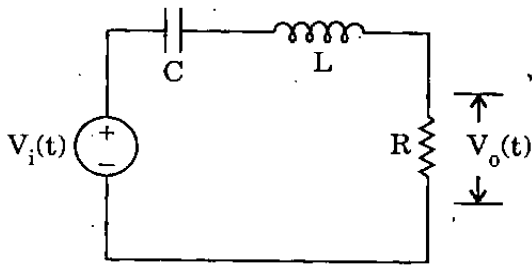

For the above shown network, the function

$$G(s) = \frac{V_o(s)}{V_i(s)} \text{ is } \frac{4s}{s^2 + 4s + 20} \text{ when } R \text{ is}$$

2 ohm. What is the value of L and C ?

- (a) 0.3 H and 1 F
- (b) 0.4 H and 0.5 F
- (c) 0.5 H and 0.1 F
- (d) 0.5 H and 0.01 F

62. The system matrix of a linear time invariant continuous time system is given by

$$A = \begin{bmatrix} 0 & 1 \\ -3 & -5 \end{bmatrix}. \text{ What is the characteristic}$$

equation ?

- (a) $s^2 + 5s + 3 = 0$
- (b) $s^2 - 3s - 5 = 0$
- (c) $s^2 + 3s + 5 = 0$
- (d) $s^2 + s + 2 = 0$

63.

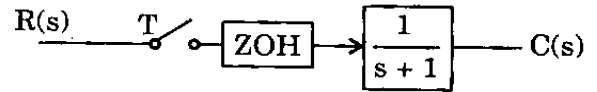

What is the transfer function $\frac{C(Z)}{R(Z)}$ of the sampled data system as shown above ?

- (a) $\frac{(1 - e^{-T})}{(Z - e^{-T})}$
- (b) $\frac{(Z - e^{-T})}{(1 - e^{-T})}$
- (c) $\frac{(1 - 2e^{-T})}{(e^{-T} - Z)}$
- (d) $\frac{(1 - 2Ze^{-T})}{(Z - 1)}$

64.

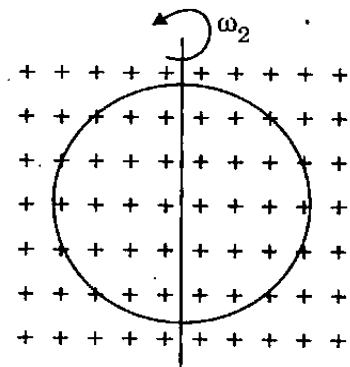

A circular loop placed perpendicular to a uniform sinusoidal magnetic field of frequency ω_1 is revolved about an axis through its diameter at an angular velocity ω_2 rad/sec ($\omega_2 < \omega_1$) as shown in the figure above. What are the frequencies for the e.m.f. induced in the loop ?

- (a) ω_1 and ω_2
- (b) ω_1 , $\omega_1 + \omega_2$ and ω_2
- (c) ω_2 , $\omega_1 - \omega_2$ and ω_2
- (d) $\omega_1 - \omega_2$ and $\omega_1 + \omega_2$

65.

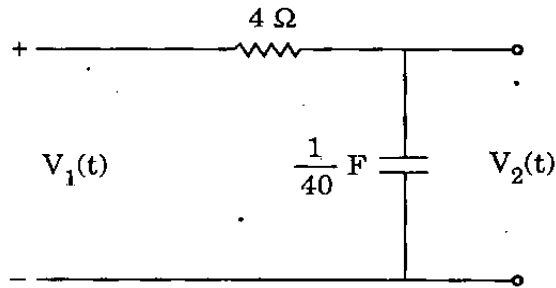

Consider the following with respect to the above circuit :

1. The transfer function of the circuit is $\frac{10}{s+10}$.
2. If $V_1(t) = 20$, $V_2(t) = 20(1 - e^{-10t})$.
3. If $V_1(t) = 20 \sin 10t$,

$$V_2(s) = \frac{2000}{(s+10)(s^2+100)}$$

Which of these is/are correct ?

- (a) 1 only
 - (b) 1 and 2
 - (c) 1, 2 and 3
 - (d) 2 only
66. What is the initial slope of Bode magnitude plot of a type-2 system ?
- (a) - 20 db/decade
 - (b) + 20 db/decade
 - (c) - 40 db/decade
 - (d) + 40 db/decade

67.

In free space

$$\vec{E}(Z, t) = 120 \pi \cos(\omega t - \beta Z) \vec{a}_x \text{ Vm}^{-1}$$

What is the average power in Wm^{-2} ?

- (a) $30\pi \vec{a}_Z$
- (b) $60\pi \vec{a}_Z$
- (c) $90\pi \vec{a}_Z$
- (d) $120\pi \vec{a}_Z$

68.

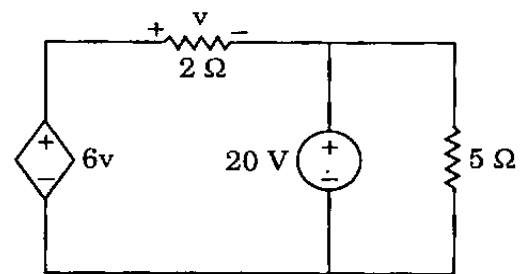

What is the current through the 2Ω resistance for the circuit as shown above ?

- (a) 5 A
 - (b) 4 A
 - (c) 3 A
 - (d) 2 A
69. The open-loop transfer function of a system has one pole in the right half of s-plane. If the system is to be closed loop stable, then $(-1 + j0)$ point should have how many encirclements in the GH-plane ?
- (a) - 2
 - (b) - 1
 - (c) + 1
 - (d) + 2

70. Consider the following statements in connection with cylindrical waveguides :

1. At low frequency the propagation constant is real and wave does not propagate.
2. At intermediate frequency the propagation constant is zero and wave cuts off.
3. At high frequency the propagation constant is imaginary and wave propagates.
4. At transition condition the cut-off frequency is inversely proportional to the eigen values of the Bessel function for the respective TE_{nr} mode.

Which of the above statements is/are correct ?

- (a) 1, 2 and 3
- (b) 2 only
- (c) 2 and 3 only
- (d) 2, 3 and 4

71.

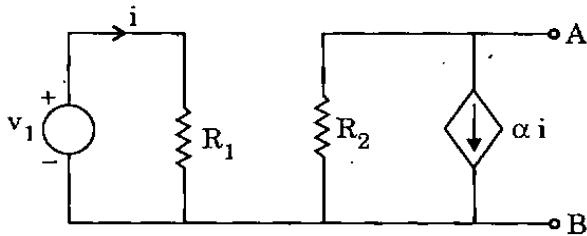

For the circuit as shown above, what are the values of the Norton's equivalent current and conductance between AB terminals ?

- (a) $-\alpha \frac{v_1}{R_1}$ and $G = \frac{1}{R_2}$
- (b) $\alpha \frac{v_1}{R_2}$ and $G = \frac{1}{R_1}$
- (c) $\alpha \frac{v_1}{R_1}$ and $G = \frac{1}{R_2}$
- (d) $-\alpha \frac{v_1}{R_1}$ and $G = -\frac{1}{R_1}$

72. A 100 kV, 50 Hz supply is fed to a rectifier ammeter (using a bridge rectifier) through a capacitor. The PMMC ammeter of the rectifier instrument reads 45×10^{-3} Amp. What is the value of the capacitor ?

- (a) 15.90×10^{-10} F
- (b) 15.90×10^{-12} F
- (c) 17.66×10^{-9} F
- (d) 17.66×10^{-11} F

73.

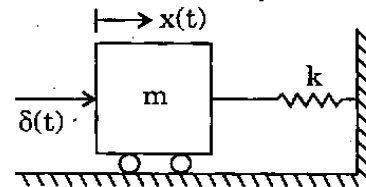

A mechanical system is as shown in the figure above. The system is set into motion by applying a unit impulse force $\delta(t)$. Assuming that the system is initially at rest and ignoring friction, what is the displacement $x(t)$ of mass ?

- (a) $\frac{1}{\sqrt{k}} \exp(-m \cdot t)$
- (b) $\frac{1}{\sqrt{mk}} \sin(t)$
- (c) $\frac{1}{\sqrt{mk}} \sin\left(\sqrt{\frac{k}{m}} \cdot t\right)$
- (d) $\frac{1}{\sqrt{mk}} \left(\sqrt{\frac{k}{m}} \cdot t\right)$

74.

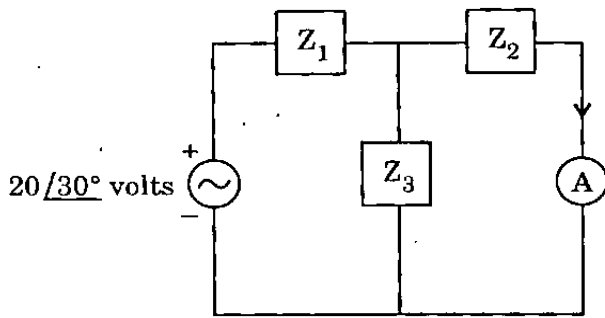

Fig. (a)

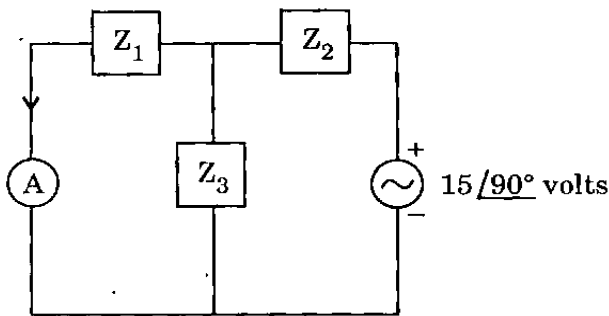

Fig. (b)

For the circuit as shown in Fig. (a), the current through the ammeter is $4 \angle -45^\circ$ Amps. What is the current in the ammeter for the circuit in Fig. (b) ?

- (a) $3 \angle 15^\circ$ Amps
- (b) $2 \angle 30^\circ$ Amps
- (c) $4 \angle 45^\circ$ Amps
- (d) $5 \angle -90^\circ$ Amps

75.

The electric field of a uniform plane wave is given by :

$$\vec{E} = 10 \sin(3\pi \times 10^8 t - \pi Z) \bar{a}_X + 10 \cos(3\pi \times 10^8 t - \pi Z) \bar{a}_Y \text{ Vm}^{-1}.$$

What is the corresponding magnetic field \vec{H} ?

- (a) $\frac{10}{377} \sin(3\pi \times 10^8 t - \pi Z) \bar{a}_Y + \frac{10}{377} \cos(3\pi \times 10^8 t - \pi Z) (-\bar{a}_X) \text{ Am}^{-1}$
- (b) $\frac{10}{377} \sin(3\pi \times 10^8 t - \pi Z) (-\bar{a}_Y) + \frac{10}{377} \cos(3\pi \times 10^8 t - \pi Z) (-\bar{a}_X) \text{ Am}^{-1}$
- (c) $\frac{10}{377} \sin(3\pi \times 10^8 t - \pi Z) \bar{a}_Y + \frac{10}{377} \cos(3\pi \times 10^8 t - \pi Z) (\bar{a}_X) \text{ Am}^{-1}$
- (d) $\frac{10}{377} \sin(3\pi \times 10^8 t - \pi Z) (-\bar{a}_Y) + \frac{10}{377} \cos(3\pi \times 10^8 t - \pi Z) (\bar{a}_X) \text{ Am}^{-1}$

76.

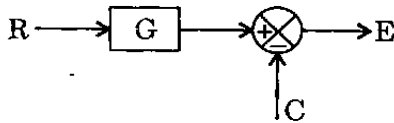

Which one of the following block diagrams is equivalent to the above shown block diagram ?

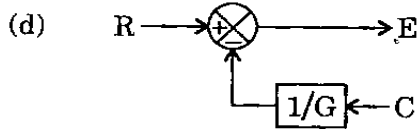
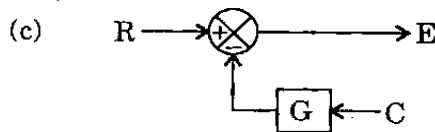
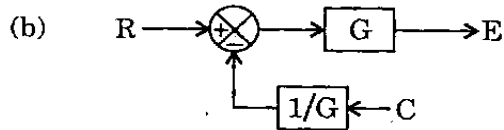
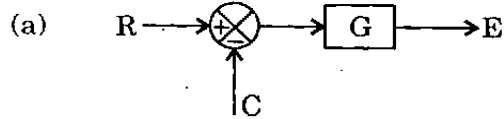

77.

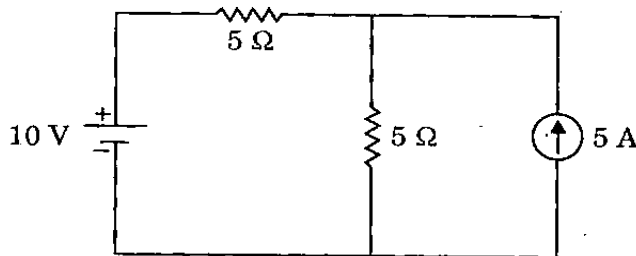

What is the voltage across the current source for the above shown circuit ?

- (a) 5.0 V
- (b) 7.5 V
- (c) 12.5 V
- (d) 17.5 V

78.

Consider the following statements :

In a Hall effect experiment, the sign of Hall voltage will change if

- 1. Direction of applied field is changed.
- 2. Direction of applied magnetic field is changed.
- 3. Direction of both applied electric and magnetic fields are changed.
- 4. Direction of current is changed.

Which of the above statements is/are correct ?

- (a) 1, 2 and 3
- (b) 3 only
- (c) 1, 2 and 4
- (d) 3 and 4

79.

Consider the following statements in connection with electromagnetic waves :

- 1. Conducting medium behaves like an open circuit to the electromagnetic field.
- 2. At radio and microwave frequencies the relaxation time is much less than the period.
- 3. In loss-less dielectric the relaxation time is infinite.
- 4. Intrinsic impedance of a perfect dielectric medium is a pure resistance.

Which of the above statements is/are correct ?

- (a) 1 only
- (b) 1 and 2 only
- (c) 2 and 3 only
- (d) 2, 3 and 4

80.

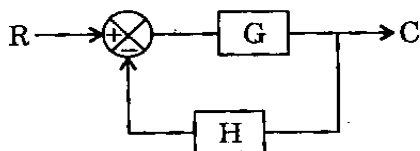

The above shown feedback control system has to be reduced to equivalent unity feedback system. Which one of the following is equivalent ?

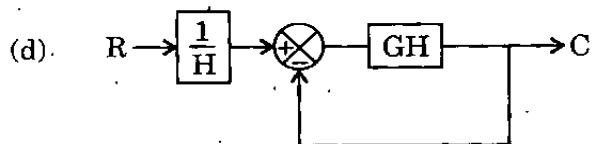
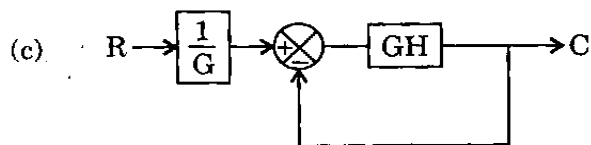
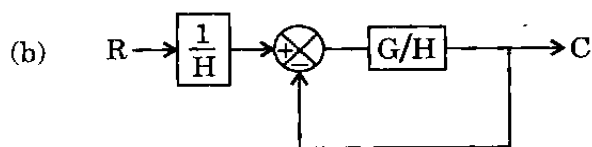
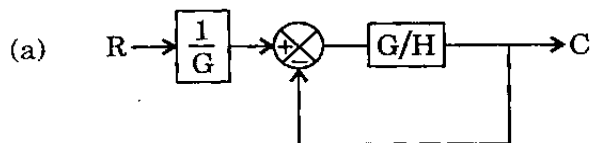

81.

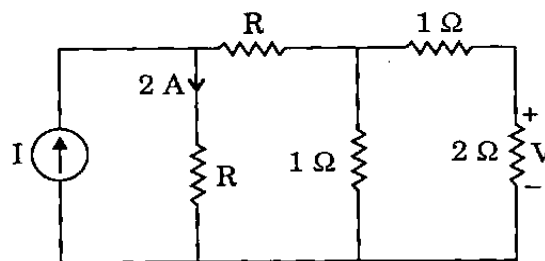

What is the value of I for the above shown circuit, if $V = 2$ volts ?

- (a) 2 A
- (b) 4 A
- (c) 6 A
- (d) 8 A

82. In semiconductor strain gauges, what happens when a tensile strain is applied ?

- (a) Resistance increases in N-type of materials
- (b) Resistance increases in P-type of materials
- (c) Resistance increases in both P and N-type of materials
- (d) Resistance decreases in both P and N-type of materials

83. For intrinsic GaAs, the room-temperature electrical conductivity is $10^{-6} (\text{ohm-m})^{-1}$, the electron and hole mobilities are, respectively, 0.85 and 0.04 $\text{m}^2/\text{V-s}$. What is the intrinsic carrier concentration n_i at the room temperature ?

- (a) 10^{21} m^{-3}
- (b) 10^{-20} m^{-3}
- (c) $7.0 \times 10^{+12} \text{ m}^{-3}$
- (d) $7.0 \times 10^{-20} \text{ m}^{-3}$

84. A second order system has a natural frequency of oscillations of 3 rad/sec and damping ratio of 0.5. What are the values of resonant frequency and resonant peak of the system ?

- (a) 1.5 rad/sec and 1.16
- (b) 1.16 rad/sec and 1.5
- (c) 1.16 rad/sec and 2.1
- (d) 2.1 rad/sec and 1.16

85. A transmission line of characteristic impedance of 50 ohm is terminated by a load impedance of $(15 - j20)$ ohm. What is the normalized load impedance ?

- (a) $0.6 - j0.8$
- (b) $0.3 - j0.6$
- (c) $0.3 - j0.4$
- (d) $0.3 + j0.4$

86. The response of an initially relaxed, linear constant-parameter network to a unit impulse applied at $t = 0$ is $4e^{-2t} u(t)$. What is the response of this network to unit step function ?

- (a) $2(1 - e^{-2t}) u(t)$
- (b) $4(e^{-t} - e^{-2t}) u(t)$
- (c) $\sin 2t$
- (d) $(1 - 4e^{-4t}) u(t)$

87.

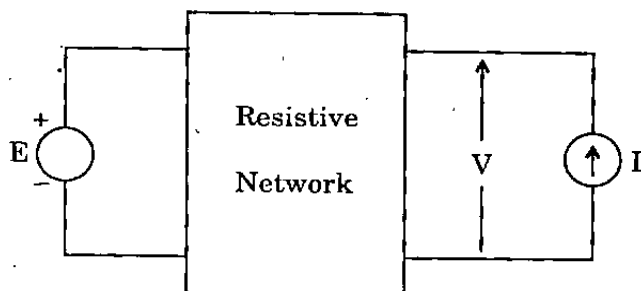

In the above shown circuit, if $V = 3$ volts for $E = 1$ volt, $I = 0$; and $V = 2$ volts for $I = 2$ A and $E = 0$. When $E = 1$ volt and I is replaced by a resistor of 2 ohm, then what is the value of V ?

- (a) 2 volts
- (b) 4 volts
- (c) 6 volts
- (d) 8 volts

88. For a certain thermistor, the material constant (β) is 3000 kelvin and its resistance at 27°C is 1050 ohm. What is the temperature coefficient of resistances for this thermistor ?

- (a) 0.033×10^{-3} ohm/ohm/ $^\circ\text{C}$
- (b) -0.033 ohm/ohm/ $^\circ\text{C}$
- (c) -3.33 ohm/ohm/ $^\circ\text{C}$
- (d) -3.0 ohm/ohm/ $^\circ\text{C}$

89. Consider the following statements :

1. A system is said to be stable if its output is bounded for any input.
2. A system is stable if all the roots of the characteristic equation lie in the left half of the s-plane.
3. A system is stable if all the roots of the characteristic equation have negative real parts.
4. A second order system is always stable for finite positive values of open loop gain.

Which of the above statements is/are correct ?

- (a) 2, 3 and 4
- (b) 1 only
- (c) 2 and 3 only
- (d) 3 and 4 only

90.

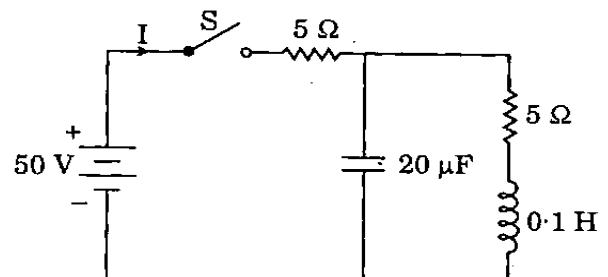

The network shown above is initially at rest. What is the initial current I when the switch S is closed at $t = 0$?

- (a) 0 A
- (b) 5 A
- (c) 10 A
- (d) 20 A

91.

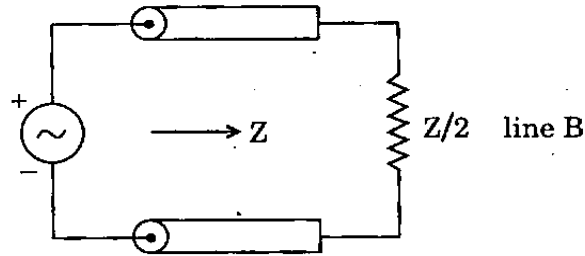
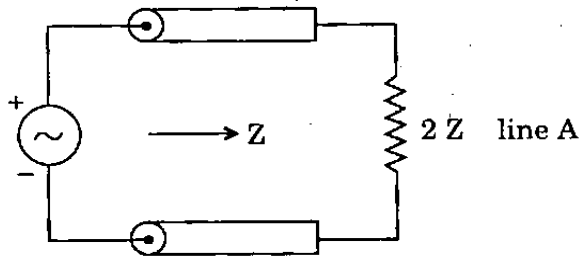

Two loss-less resistive transmission lines each of characteristic impedance Z are connected as shown in the circuits above. If the maximum voltage on the two lines is the same and the power transmitted by line A is W_1 , then what is the power transmitted by the line B ?

- (a) $4 W_1$
- (b) $3 W_1$
- (c) $2 W_1$
- (d) $1 W_1$

92.

The open loop transfer function of a closed loop control system is given as :

$$G(s)H(s) = \frac{K(s+2)}{s(s+1)(s+4)^2}$$

What are the number of asymptotes and the centroid of the asymptotes of the root-loci of closed loop system ?

- (a) $-3; \left(\frac{7}{3}, 0\right)$
- (b) $-2; (2, 0)$
- (c) $3; \left(\frac{-7}{3}, 0\right)$
- (d) $2; (-2, 0)$

93.

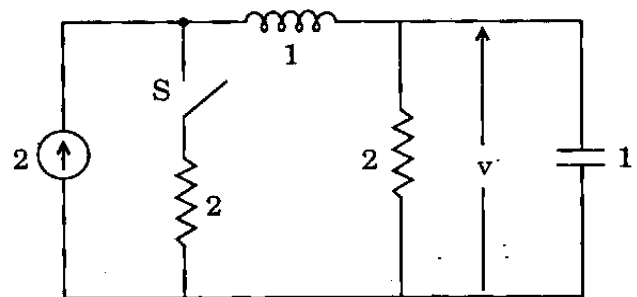

The circuit as shown above is in the steady state. The switch S is closed at $t = 0$. What are the values of v and $\frac{dv}{dt}$ at $t = 0^+$?

- (a) 0 and 4
- (b) 4 and 0
- (c) 2 and 0
- (d) 0 and 2

94. The transfer function of a phase-lead compensator is given by :

$$G(s) = \frac{1+3Ts}{1+Ts} \text{ where } T > 0. \text{ What is the}$$

maximum shift provided by such a compensator ?

- (a) 90°
- (b) 60°
- (c) 45°
- (d) 30°

95.

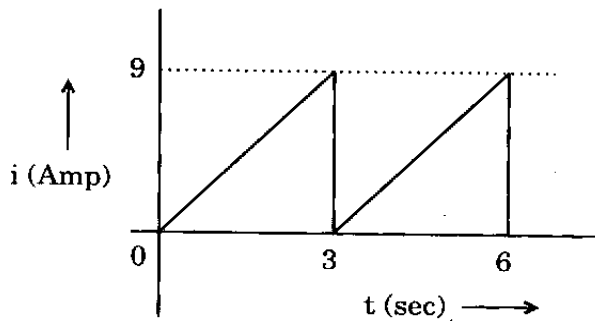

The current waveform as shown above, is applied in a pure resistor of 10Ω . What is the power dissipated in the resistor ?

- (a) 270 W
- (b) 135 W
- (c) 52 W
- (d) 7 W

96. Consider the following statements :

1. A phase lead network provides a positive phase angle over the frequency range of interest.
2. Armature controlled d.c. servo motor is inherently a closed-loop system.
3. Phase lag network provides significant amplification over the frequency range of interest.
4. Transfer functions with zeroes in the right half of s-plane is a non-minimum system.

Which of the above statements is/are correct ?

- (a) 3 only
- (b) 1 and 2 only
- (c) 1, 2 and 4
- (d) 2, 3 and 4

97.

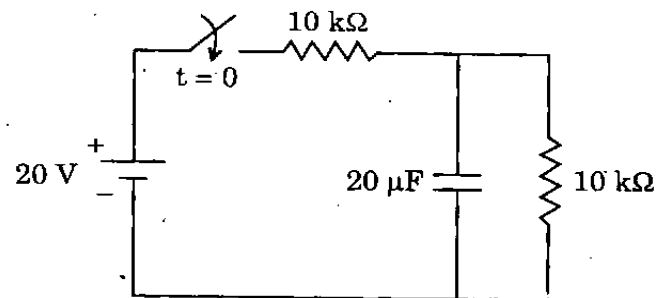

The switch of above circuit was open for long, and at $t = 0$ it is closed. What is the final steady state voltage across the capacitor and the time-constant of the circuit ?

- (a) 0 V and 0.1 sec
- (b) 20 V and 0.2 sec
- (c) 10 V and 0.2 sec
- (d) 10 V and 0.1 sec

98. A linear system is described by the following state equations :

$$\dot{X}(t) = \begin{bmatrix} 0 & -2 \\ 1 & -3 \end{bmatrix} X + \begin{bmatrix} 2 \\ 0 \end{bmatrix} Y$$

$$Y(t) = [0 \quad 3] X$$

What is the transfer function of the system ?

(a) $\frac{1}{s^2 + 2s + 3}$

(b) $\frac{6}{s^2 + 3s + 2}$

(c) $\frac{6}{s^2 + 2s + 3}$

(d) $\frac{1}{s^2 + 3s + 2}$

99. A transmission line section shows an input impedance of 36Ω and 64Ω respectively, when short circuited and open circuited. What is the characteristic impedance of the transmission line ?

(a) 100Ω

(b) 50Ω

(c) 45Ω

(d) 48Ω

100. The poles and zeroes of an all-pass network are located in which part of the s-plane ?

(a) Poles and zeroes are in the right half of s-plane

(b) Poles and zeroes are in the left half of s-plane

(c) Poles in the right half and zeroes in the left half of s-plane

(d) Poles in the left half and zeroes in the right half of s-plane

101. When a transfer function model is converted into state space model, the order of the system may be reduced during which one of the following conditions ?

(a) Some of the variables are not considered

(b) Some of the variables are hidden

(c) Pole, zero cancellation takes place

(d) The order of the system will never get changed

102. How can the power supplied to a high frequency heating system be measured ?

(a) By dynamometer wattmeter

(b) By induction wattmeter

(c) By thermocouple type wattmeter

(d) By moving iron ammeter and voltmeter

103. In an RLC series resonant circuit, if the maximum stored energy is increased by 10% and at the same time the energy dissipated per cycle is reduced by 10%, it will result in which one of the following ?

- (a) An 11% decrease in quality factor
- (b) An increase in the resonant frequency by 11%
- (c) A 22% increase in quality factor
- (d) A decrease in the resonant frequency by 22%

104. If D is the rotor diameter and L , the axial length, then a high performance a.c. servomotor is characterized by which one of the following ?

- (a) Large D and Large L
- (b) Large D and Small L
- (c) Small D and Small L
- (d) Small D and Large L

105. Why is the network function,

$$N(s) = \frac{s^3 + 3s}{s^4 + 4s^2 + 4} \text{ not positive real ?}$$

- (a) The highest degree of numerator and denominator polynomials differ by one
- (b) The terms of the lowest degree in the numerator and denominator polynomials differ in degree by one
- (c) The poles and zeroes have zero real parts
- (d) It has multiple poles on the imaginary axis

106. Consider the following statements with reference to hydraulic systems :

1. A small size actuator can develop a very large force or torque.
2. A source with supply and return line is required.
3. It is insensitive to temperature changes.

Which of the above statements is/are correct ?

- (a) 1 only
- (b) 2 only
- (c) 1 and 2
- (d) 2 and 3

107.

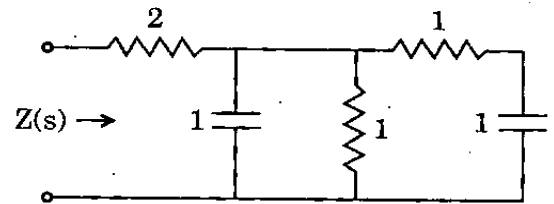

The network realization of RC impedance function, $Z(s) = \frac{(\alpha s^2 + 7s + 3)}{(s^2 + 3s + \beta)}$ is as shown above. What are the values of α and β ?

- (a) 1 and 2
- (b) 2 and 1
- (c) 2 and 3
- (d) 3 and 2

108. Which one of the following is **not** the criterion used to select potentiometer in a control system ?

- (a) Accuracy
- (b) Noise
- (c) Time response
- (d) Frequency response

109.

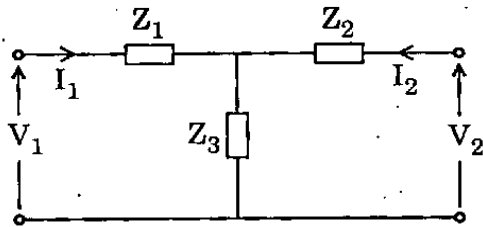

If the Z-parameters for the T-network as shown above are $Z_{11} = 40 \Omega$, $Z_{22} = 50 \Omega$ and $Z_{12} = Z_{21} = 30 \Omega$, then what are the values of Z_1 , Z_2 and Z_3 ?

- (a) 10Ω , 20Ω and 30Ω
- (b) 20Ω , 30Ω and 20Ω
- (c) 30Ω , 40Ω and 10Ω
- (d) 40Ω , 50Ω and 10Ω

Directions : Each of the next eleven (11) items consists of two statements, one labelled as the 'Assertion (A)' and the other as 'Reason (R)'. You are to examine these two statements carefully and select the answers to these items using the codes given below :

Codes :

- (a) Both A and R are individually true and R is the correct explanation of A
- (b) Both A and R are individually true but R is *not* the correct explanation of A
- (c) A is true but R is false
- (d) A is false but R is true

110. **Assertion (A) :** The semiconductor material used in making an optical source should be a direct bandgap material.

Reason (R) : Carrier recombination time is shorter in a direct bandgap semiconductor.

111. **Assertion (A) :**

A capacitor has one pole at $s = \infty$ and one zero at $s = 0$, where $s = j\omega$, ω is the angular frequency.

Reason (R) :

The driving point impedance of a capacitor is $\frac{1}{sC}$.

112. **Assertion (A) :**

To increase the range of an ammeter to measure high currents, it is required to connect a high resistor in shunt across the ammeter.

Reason (R) :

The shunt resistor will divert the excess current and allow only the rated current to pass through the deflecting system of the ammeter.

113. **Assertion (A) :**

The sensitivity of a voltmeter is often expressed in terms of ohms-per-volt.

Reason (R) :

High sensitivity voltmeters use a basic d'Arsonval meter which has high sensitivity.

114. Assertion (A) : In a bridge type of measurement, it is required that the indicator used to show the balance condition of the bridge should have very high sensitivity.

Reason (R) : The accuracy of the null-indicator does not play any role in a bridge measurement.

115. Assertion (A) : An electronic millivoltmeter used to read very low a.c. voltages at high frequencies is an amplifier-rectifier type of meter.

Reason (R) : The diodes cannot rectify low a.c. voltages of millivolt order.

116. Assertion (A) : Electron beam switch is used in a multitrace CRO.

Reason (R) : Electron beam switch synchronizes the input signal and gives a steady waveform on the CRO screen.

117. Assertion (A) : Random errors can be minimized by statistical methods.

Reason (R) : These are caused by arithmetic error while taking readings.

118. Assertion (A) : The stator windings of a control transformer has higher impedance per phase.

Reason (R) : The rotor of a control transformer is cylindrical in shape.

119. Assertion (A) : Addition of a pole to the forward path transfer function of unity feedback system increases the rise time of step response.

Reason (R) : The additional pole has the effect of increasing the bandwidth of the system.

120. Assertion (A) : Knowing magnetic vector potential \vec{A} at a point, the flux density \vec{B} at that point can be obtained.

Reason (R) : $\vec{\nabla} \cdot \vec{A} = 0$.

SPACE FOR ROUGH WORK

SPACE FOR ROUGH WORK

SPACE FOR ROUGH WORK

SPACE FOR ROUGH WORK