

Q1 Please tick the correct answer for the following questions below

10

1. White-grey-black is _____ color scheme
Achromatic Monochromatic Polychromatic
2. Analogous colors are 3 colors _____ to each other
Adjacent Opposite Away
3. If soft curve gives you a feeling of happiness, then which type of line will give you a feeling of being bold and confident?
Vertical Zigzag Bumperty
4. Protractor is a tool used for measuring _____
Angle Line Diameter
5. Millimetre is _____ unit than centimeter
Longer Bigger Wider
6. Heptagon is a _____ polygon
Equal Regular Irregular
7. When was budget presented for the year 2016-17?
27th Feb 28th Feb 29th Feb
8. Which team won Pro Kabbadi League 2016?
Patna Pirates U Mumba Puneri Paltan
9. Flipkart is owned by _____
Manuj & Gagan Bansal Sachin & Binny Bansal Rahul & Rohit Bansal
10. International yoga day is celebrated on _____
21st April 21st May 21st June

Q1 Please tick the correct answer for the following questions below

05

11. In a coded language PHOTO is written as OGNSN. How will you write FASHION?
 EZRGHNM EZGGHN ENBCDE
12. If ZEBRA can be written as 2652181, how can COBRA be written?
 302181 3152181 31822151
13. If 'eraser' is called 'box', 'box' is called 'pencil', 'pencil' is called 'sharpener', and 'sharpener' is called 'bag', what will a child write with?
 Bag Pencil Sharpner
14. Which of these is not a comic character?
 Chacha Chaudhary Batman Berry
15. What are Bharatanatyam and Kathak related to?
 Folk Tales Classical Dances Theatre Performances
16. Priyanka Chopra wore a gown designed by _____ for the Oscar 2016.
 Christian Dior Prada Elie Saab
17. The designer to be given a special award at Filmfare Awards for movie Bajirao Mastani is _____
 Ritu Kumar Sabyasachi Mukherjee Anju Modi
18. The first Indian designer to get the Chevalier de la Légion D'honneur is _____
 Manish Arora Manish malhotra Satya paul
19. Sonam Kapoor is a very famous _____
 Fashion Designer Fashionista Fashion Stylist
20. Leheriya is a craft from the state of _____
 Gujarat Maharashtra Rajasthan

Q1 Please underline the correct answer for the following questions below

10

21. Which of the figures can be used to continue the series given below?

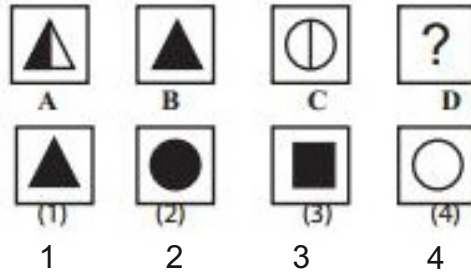

22. Which of the figures can be used to continue the series given below?

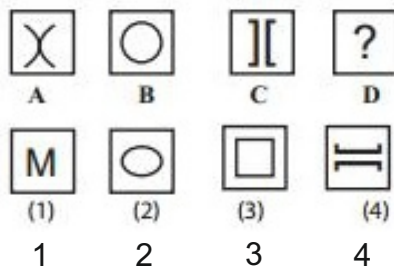

23. Which of the figures is an odd one out?

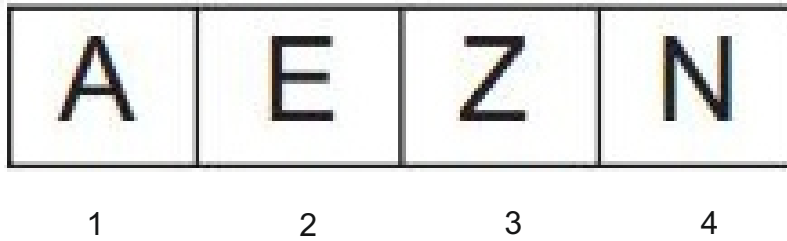

24. Please enter the missing figure 12,1215,17,17121215,18,_____

121517

12121517

181212151717121215

25. 148896 is to button as 146 is to _____

Tune

Bun

Top

Q1 Please name the garments / accessories from the pictures given below

05



Q1 Please name the personalities and their respective areas of service.

10



Q2 Imagine yourself to be a florist. What 4 flower arrangements will you style for different occasions? Please explain ideas through sketches in boxes given below.

10

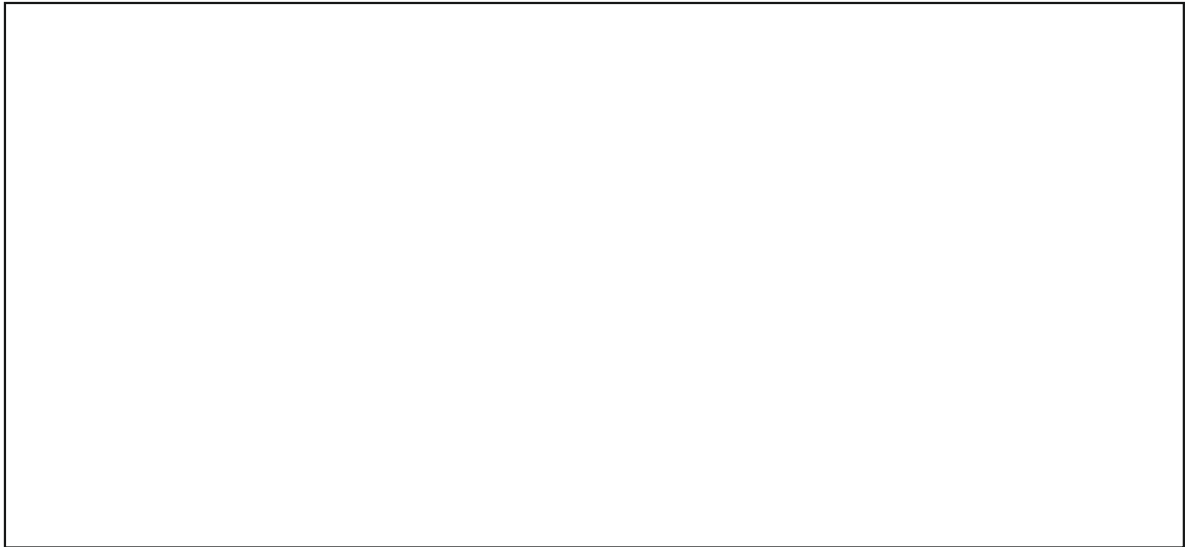



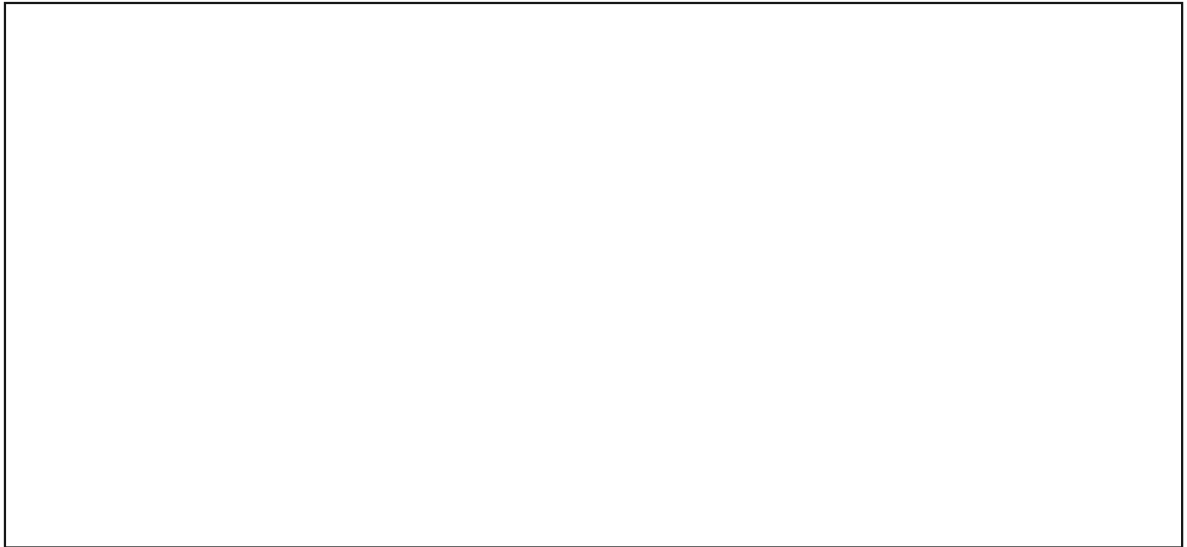

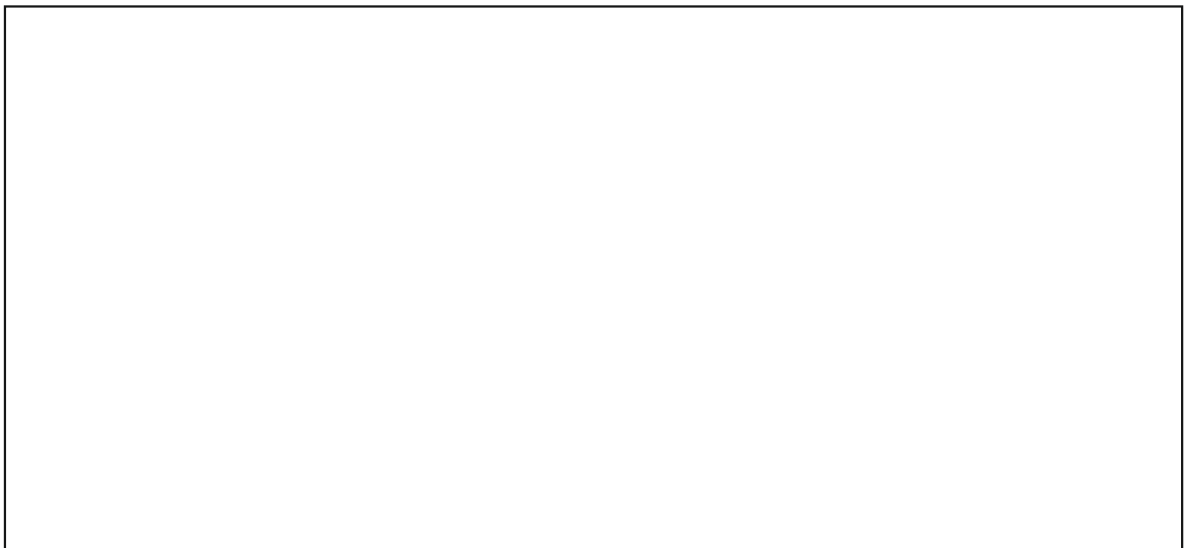

Q2 Draw the parts of Polo Shirt proportionately on the sketch provided . Name these parts on page number 09.

10

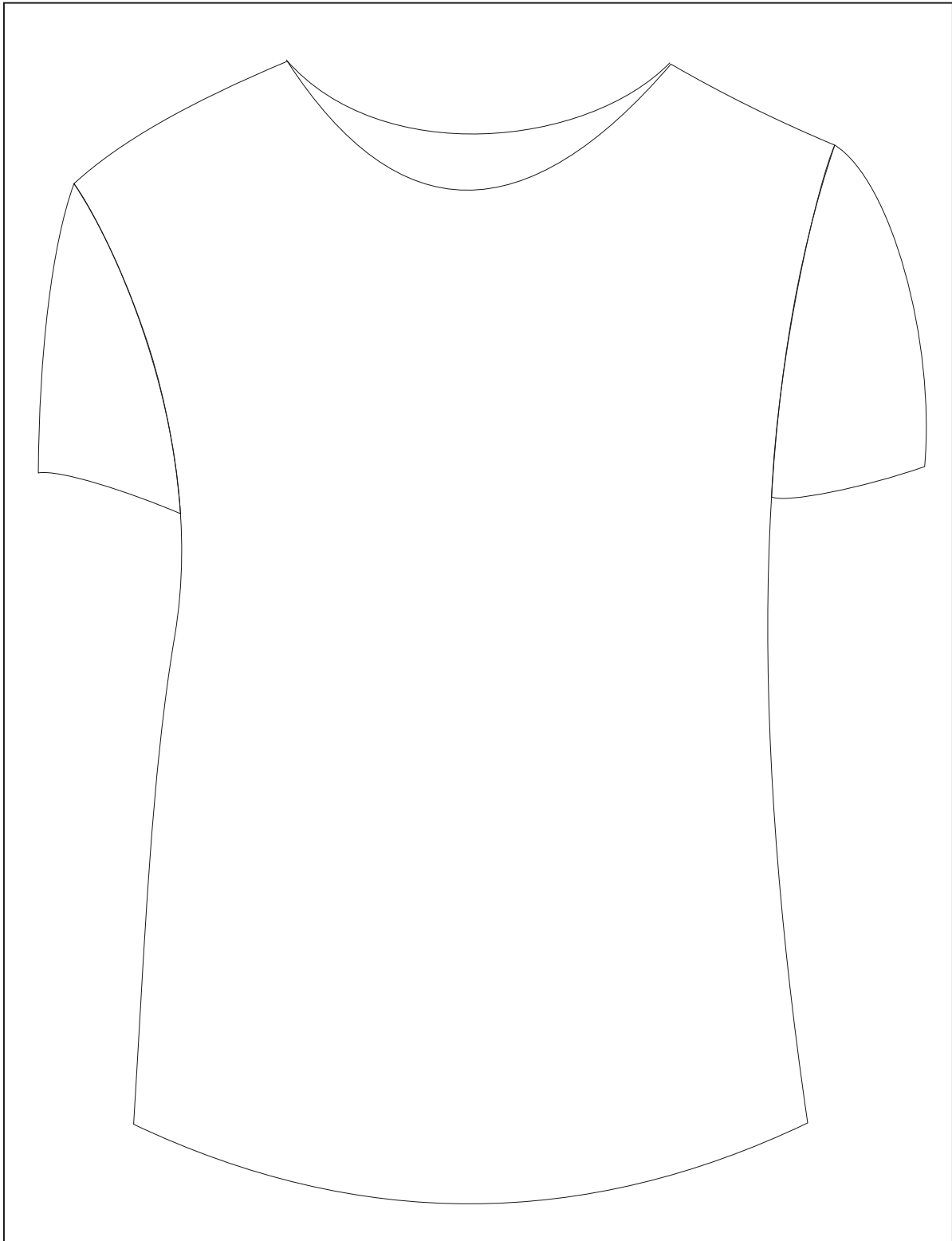

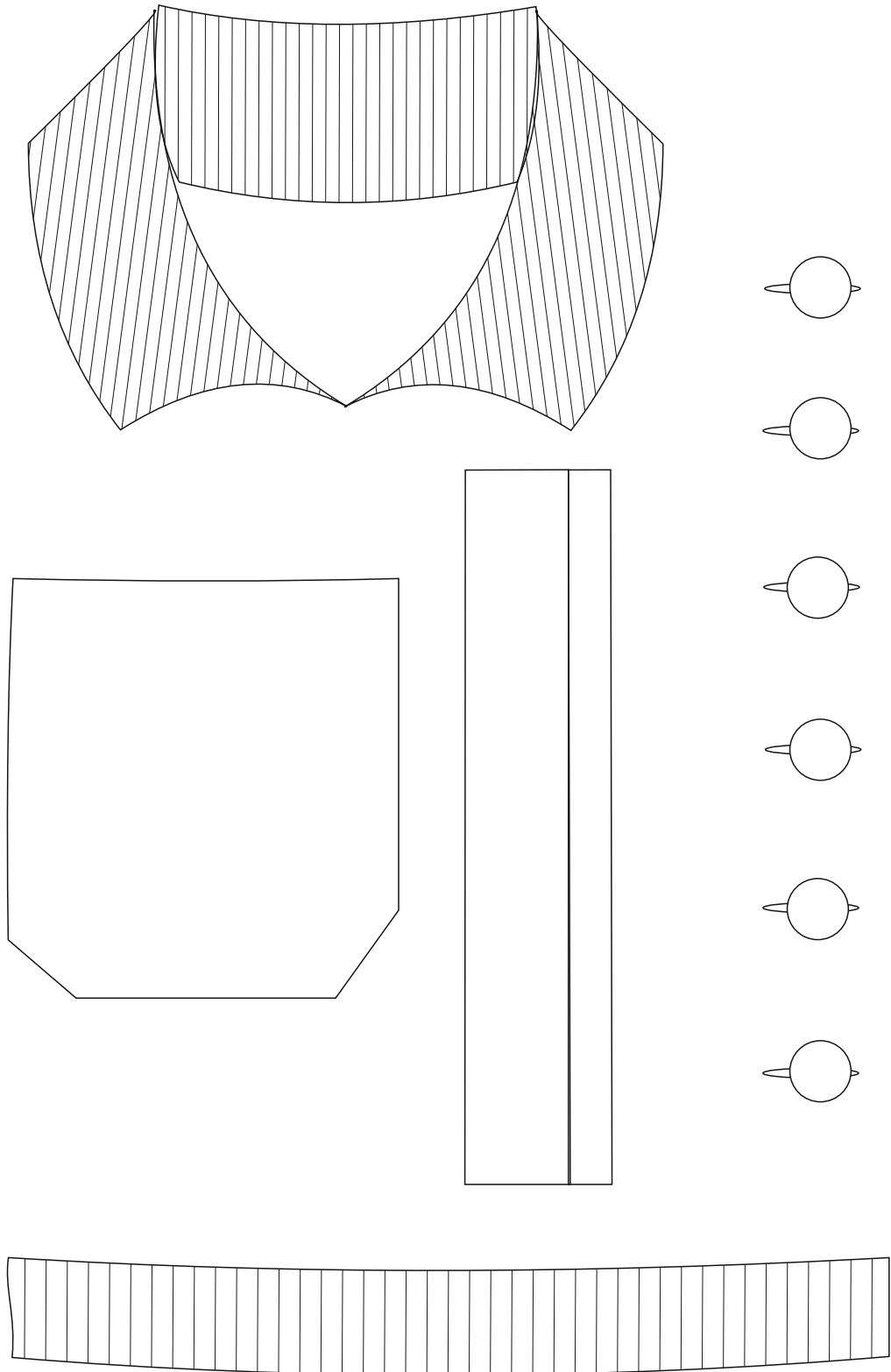

Q4 Please read the comprehension and answer the questions given below.

10

The worst days of any summer are the rainy ones. We spend all year looking forward to nice weather and long, hot days. All of winter, with its dreary gray days and bitter cold, we dream of those endless days at the beach, laying on the sand and soaking in the bright and burning sun. And then, summer comes, and it rains.

As a child, I would wake up to rainy summer days and come close to crying. It wasn't fair. We suffered through months of school and miserable weather for those scant ten weeks of freedom and balmy weather. Any day that I could not spend at the beach or playing ball with my friends seemed like a punishment for something I didn't even do.

On those rainy summer days, I had nothing fun to do and could only sit inside, staring out at the rain like a Dickensian orphan. I was an only child, so there was no one else to play with. My father worked from home, so I was not truly alone, but he could not actively play with me since he was technically at work. It was those days that I would resign myself to whatever was on television or any books that I could find lying around. I'd crawl through the day and pray each night that the rain would not be there the next day.

As an adult, though, my opinion of summer rain has changed. When you have to work every day, summer is not as eagerly anticipated. Mostly, the days run together, bleeding into each other so that they no longer seem like separate entities and instead feel like continuations of the same long day. Everything seems monotonous and dull, and an ennui or listlessness kicks in. Such a mindset makes you cheer for anything new or different. I spend the winter dreaming of summer and the summer dreaming of winter.

When summer comes, I complain about how hot it is. And then I look forward to the rain, because the rain brings with it a cold front, which offers a reprieve admittedly one that is all too short from the torture of 100° and humid days. Rainy days are still the worst days of the summer, but summer rain today means positively beautiful and considerably cooler weather tomorrow.

1. The passage makes use of language that is _____
 - A. metaphorical
 - B. rhetorical
 - C. formal
 - D. ambiguous

2. According to the passage, summer is different for adults because
 - A. rain brings with it cold temperatures for the following days
 - B. the weather is much warmer than it is for children
 - C. they do not get a long time off from work for the season
 - D. they better know how to occupy their downtime

3. According to the passage, which of the following is a true statement about the narrator as a child?
 - A. he or she was often bored on summer days.
 - B. he or she preferred cooler weather.
 - C. he or she liked staying indoors.
 - D. he or she had no siblings.

4. Compared to how he or she was as a child, the narrator as an adult is _____
 - A. more realistic
 - B. less excitable
 - C. more idealistic
 - D. less calm

5. As used in the final paragraph, the word *reprieve* most nearly means
 - A. a permanent conclusion
 - B. a short continuation
 - C. a higher level of pain
 - D. a temporary break

Q6 Use the following words to individually express in the form of drawing/sketch/doodle. Explain your sketch in the given space.

10

1. Joy

2. Study

3. Anger

4. Celebration

5. Examination
