

Undergraduate Common Entrance Examination for Design

UCEED 2019

Question Paper



Indian Institute of Technology Bombay

Paper Specific Instructions

1. The examination is of 3 hours duration. There are a total of **85 questions** carrying a total of 300 marks. The paper is divided into three sections, **A, B** and **C**. All sections are compulsory. Questions in each section are of different types.
2. **Section A (60 Marks)** contains a total of 20 **Numerical Answer Type (NAT)** questions. For each question, the answer is a real number that needs to be entered using the virtual keyboard on the monitor. No choices will be shown for these questions. There is **NO NEGATIVE** marking for this section. Each correct answer will be awarded 3 marks. Questions not attempted or answered incorrectly will be given zero mark. Questions from 1 to 20 belong to this section.
3. **Section B (60 Marks)** contains a total of 20 **Multiple Select Questions (MSQ)**. Each question may have **one or more than one correct choice(s)** out of the four given. A question is considered correctly answered if ALL the correct choices and NO wrong choices are selected for that question. There is NEGATIVE marking for this section. Each question answered correctly will receive 3 marks. Each question wrongly answered will receive -0.19 (minus zero point one nine) mark. There is NO PARTIAL marking for this section. Questions not attempted will be given zero mark. Questions from 21 to 40 belong to this section.
4. **Section C (180 Marks)** contains a total of 45 **Multiple Choice Questions (MCQ)**. Each question has four choices out of which ONLY ONE is the correct answer. There is NEGATIVE marking for this section. Each correct answer will be awarded 4 marks and each wrong answer will receive -1.32 (minus one point three two) mark. Questions not attempted will be given zero mark. Questions from 41 to 85 belong to this section.
5. Calculators, charts, graph-sheets, mathematical tables, mobile phone, smart watches and/or other electronic gadgets are **NOT** allowed in the examination hall.
6. Blank sheets of paper will be provided for rough work.
7. Marking Scheme for the paper is given in the table below.

Section	Number of questions	Marks for each correct answer	Marks for each wrong answer	Marks for each question not attempted	Total marks for the section
NAT	20	3	0	0	60
MSQ	20	3	-0.19	0	60
MCQ	45	4	-1.32	0	180
Total	85				300

Section A: Numerical Answer Type Questions

Section A (60 Marks) contains a total of 20 Numerical Answer Type (NAT) questions. For each question, the answer is a real number that needs to be entered using the virtual keyboard on the monitor. No choices will be shown for these questions. There is **NO NEGATIVE** marking for this section. Each correct answer will be awarded 3 marks. Questions not attempted or answered incorrectly will be given zero mark. Questions from 1 to 20 belong to this section.

Q.01 Shown below are sole designs of slippers, of which some are matched-pairs (one left foot and one right foot). Identify the total number of matched-pairs in the image.



Q.02 X1 is a 3D form generated from the shape X, using certain 3D operations. It has 11 surfaces in total. If the same operations are carried out on shape Y, how many surfaces would the resulting 3D form have?

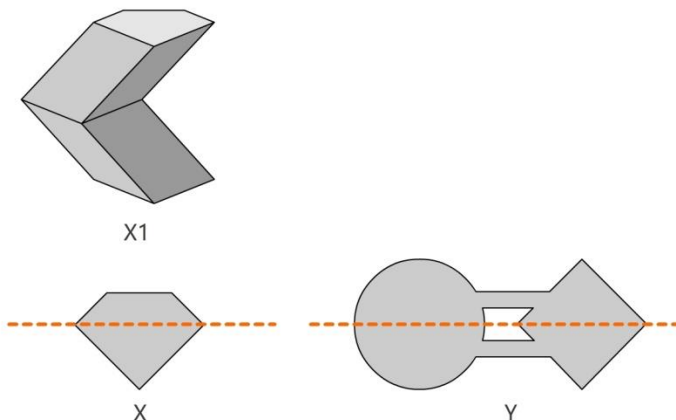

Q.03 Fifteen people from different places came together for a family reunion. Each one of them had two gifts each for every other person. When the gifts were exchanged they hugged each other. What is the difference between the number of hugs and the number of gifts exchanged?

Q.04 A tetrahedral puzzle is made of smaller tetrahedrons. Shown below is one side of the puzzle and a small tetrahedron. Assuming that all the faces of the puzzle are the same, how many small tetrahedrons are there on the faces of the larger tetrahedron?

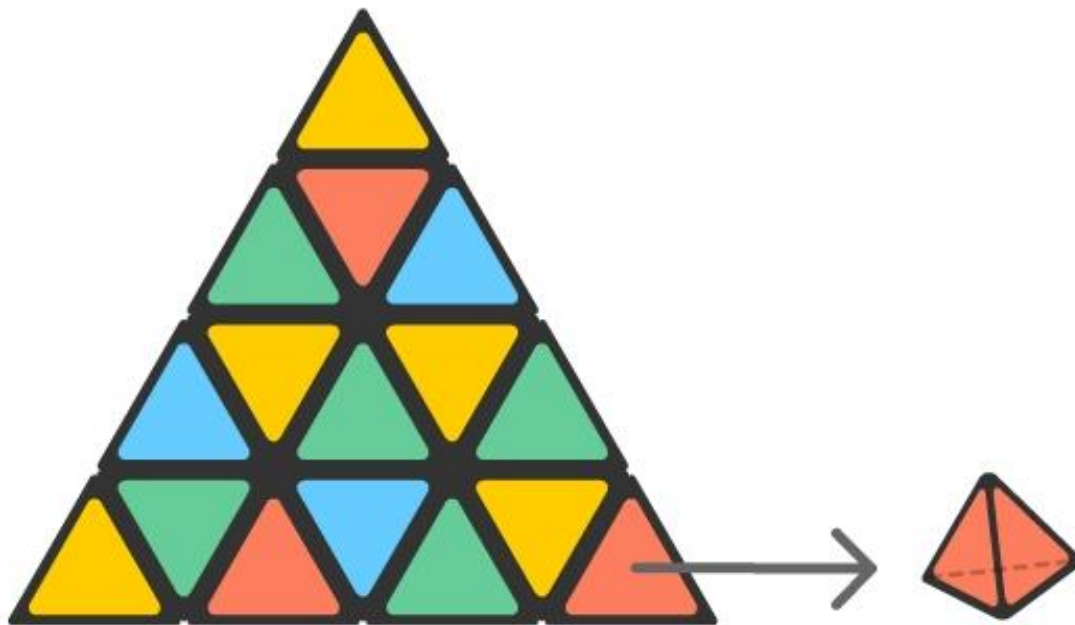

Q.05 The picture shows decimal numbers encoded in colors in some other number system. Encodings of six numbers have been given in the picture on the left. Picture on the right shows a multiplication that we need to perform. What decimal number represents the result of this multiplication?

0	 	21	
3	 	23	
10	 	24	

×

Q.06 A cube has its six faces *numbered* 1 to 6. A school boy tosses up the cube twice and notes down the two numbers appearing on top in these two tosses. He multiplies these two numbers and notes down the multiplication result. How many unique multiplication results can he possibly get through this tossing game?

Q.07 Three transparent glass pieces with different engravings are shown below. They are to be overlapped, one on top of the other, with the red corner exactly matching each other. What is the total number of triangles in the resultant figure?

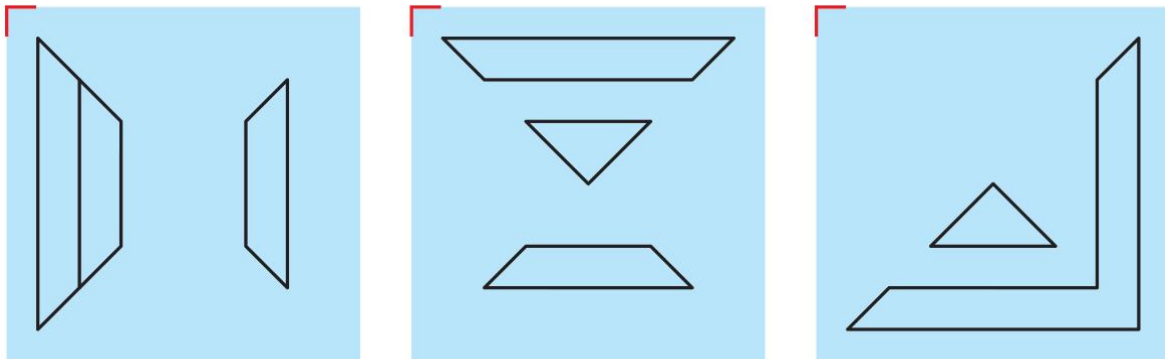

Q.08 A diagram of three blocks A, B and C and their direction of movement is shown below. The blocks move continuously in units and change directions after hitting the side walls. From the given position, if block A moves at a speed of 2 units per second, and block B and block C move at a speed of 1 unit per second, what is the least time (in seconds) that is required for all blocks to align exactly one below the other?

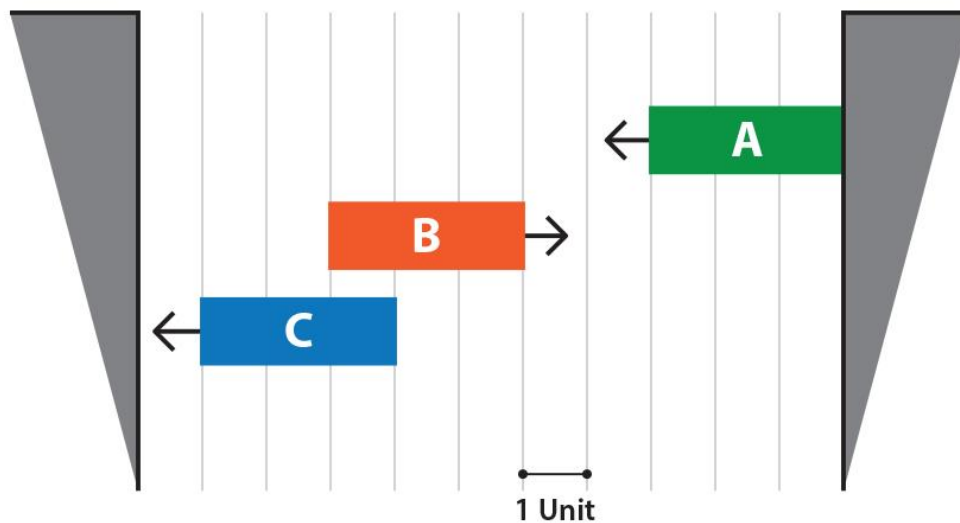

Q.09 A UNION of two solids, a pentagonal prism and a hexagonal prism is shown below. The side view (on the right) depicts how the solids intersect. Visualise the new solid formed by their INTERSECTION (the part common to both of them). How many surfaces will the new solid have?

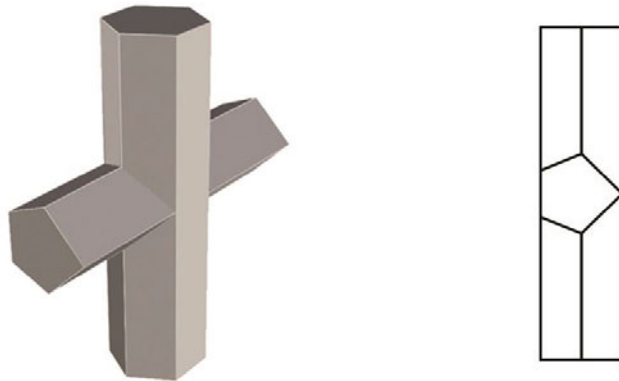

Q.10 A solid object made of cubes is shown below. This object is symmetric about all three axes, and does not contain cavities (no hollow spaces). How many cubes does the solid contain?

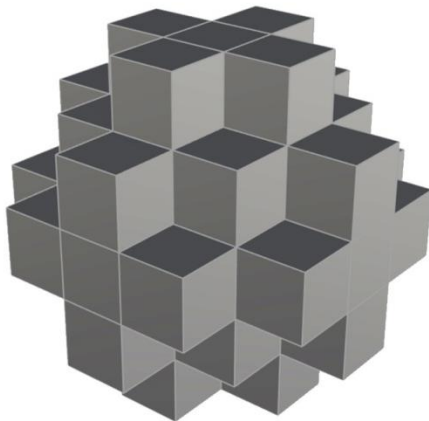

Q.11 A solid is drilled using a cylindrical drill in a direction, as shown below. How many surfaces will the solid have after the drilling is complete?

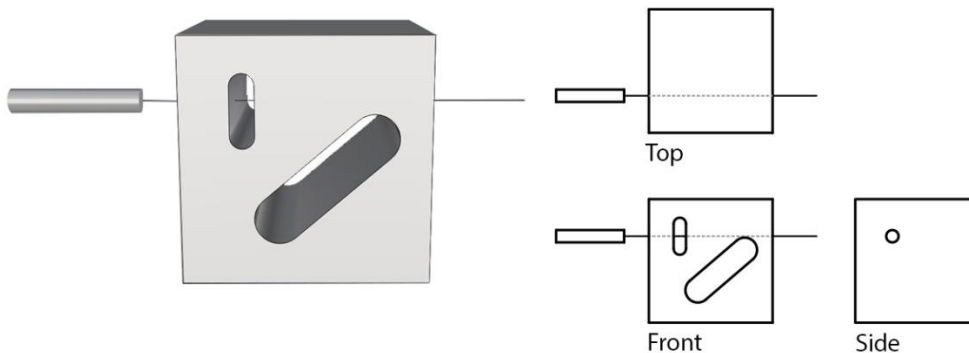

Q.12 The figure below shows a hinged structure made up of 12 sticks. The structure can be elongated and compressed by changing the angle ABR. As shown in the figure, the distance between B and Q is $150\sqrt{6}$ (one hundred and fifty times root six) units when the angle ABR is 90 degrees. What will this distance be when the angle ABR is changed to 60 degrees?

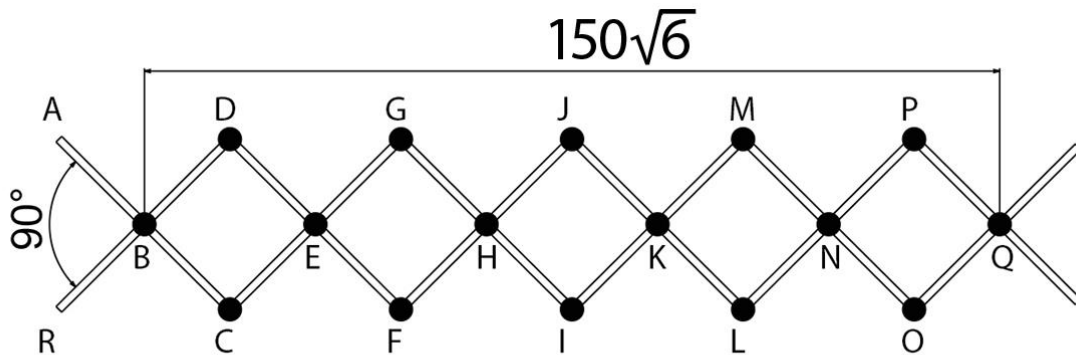

Q.13 In a new form of decimal system, the numbers 0 to 9 are represented by a new set of symbols. For example, the equation $1 + 4 = 5$ is represented as equation (i). If in the solution to equation (iv) one digit appears twice, what number will replace the question mark?

- (i) $1 + 4 = 5$
- (ii) $4 + 7 = 11$
- (iii) $11 - 4 = 7$
- (iv) $111 + 111 = ?$

Q.14 What is the area (in cm^2) of the black portion, if the square is of length 16 cm?

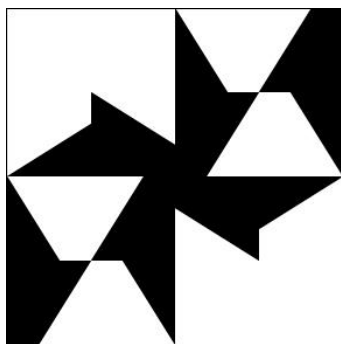

Q.15 The figure shows two concentric equilateral triangles with a circle within, such that the circle touches all the edges of the triangle. If the radius of the circle is $\sqrt{3}$ (square root of three), what is the total length of the star shaped outer border formed by the two intersecting triangles?

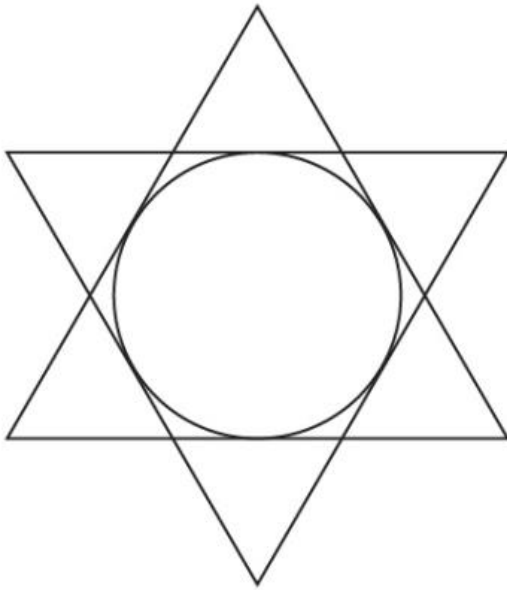

Q.16 Except for one number, all the four-digit numbers given below are written using a single font. Identify the number that does not use the same font as the other numbers.

3697 5574 1767 6367 5985
 7514 3683 3270
 1676 8431 3584 2018
 1450 1070 4208 1190
 3601 1847 8504 8075
 6063 2044
 1502 7070 4338 3015
 6049 1342 8075 4852

Q.17 Two perspective views of the same solid object are shown below. Count the total number of surfaces in the object. Assume hidden surfaces to be flat.

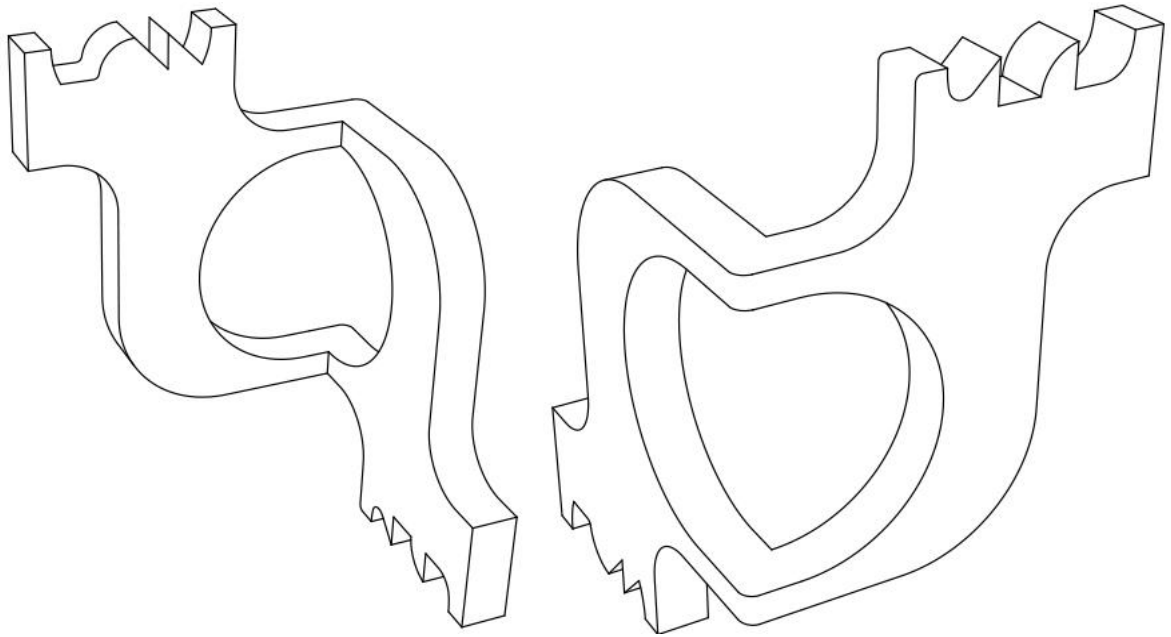

Q.18 The image given below is made out of separate pieces. What is the least number of pieces that need to be moved and/or rotated and/or flipped for achieving symmetry about the central vertical axis?

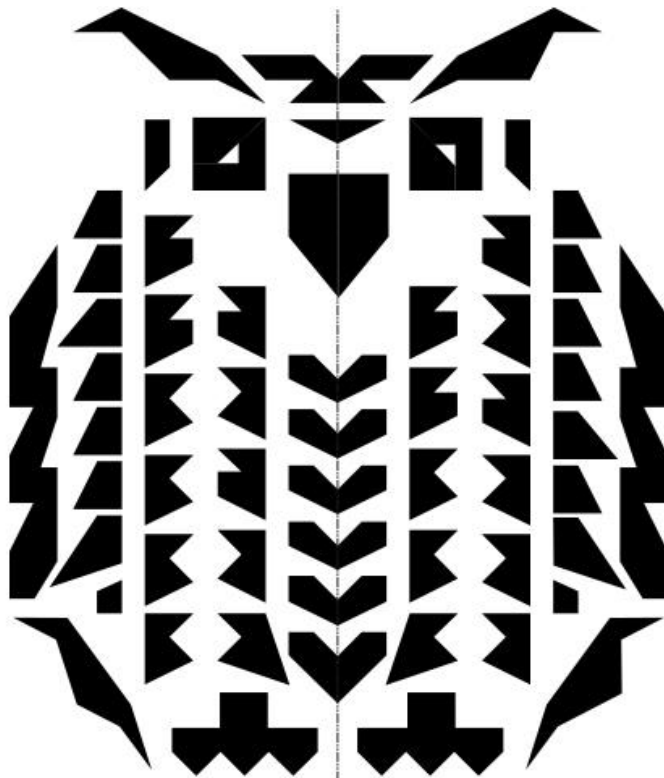

Q.19 A logo was designed by creating a pattern of orange petals using four semicircles. These petals were then inscribed in a green circular shape with an inner diameter of $14\sqrt{2}$ (fourteen times square root of two) units, what is the area of the orange part in the logo? (Assume $\pi = 22/7$)



Q.20 Shyam runs a dairy. In his cattle herd, each white cow gives 12 litres of milk, each brown cow gives 7 litres of milk and each yellow cow gives 10 litres of milk every day. He has drawn a sketch of his herd which is shown below. Using this sketch, calculate the amount of milk (in litres) produced by his dairy per day?

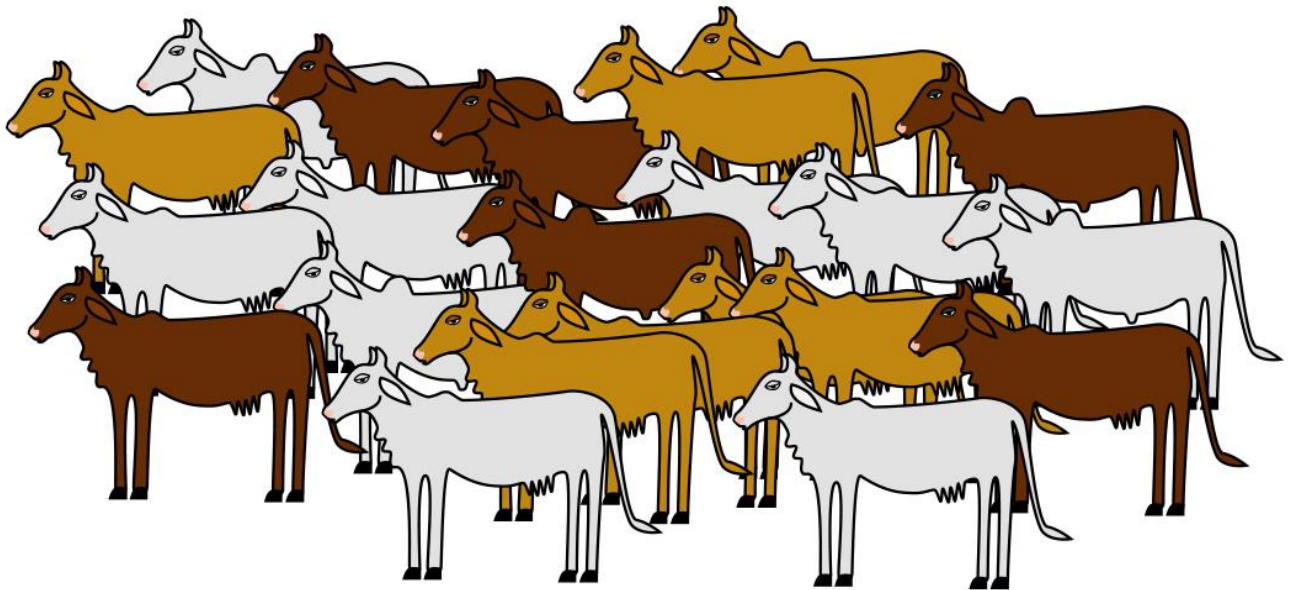

Section B: Multiple Select Questions

Section B (60 Marks) contains a total of 20 **Multiple Select Questions (MSQ)**. Each question may have **one or more than one correct choice(s)** out of the four given. A question is considered correctly answered if **ALL** the correct choices and **NO** wrong choices are selected for that question. There is **NEGATIVE** marking for this section. Each question answered correctly will receive 3 marks. Each question wrongly answered will receive -0.19 (minus zero point one nine) mark. There is **NO PARTIAL** marking for this section. Questions not attempted will be given zero mark. Questions from 21 to 40 belong to this section.

Q.21 Tile X was used to create a seamless pattern when arranged as shown below. Which tile(s) from the options will create a seamless pattern (pattern without gaps)?

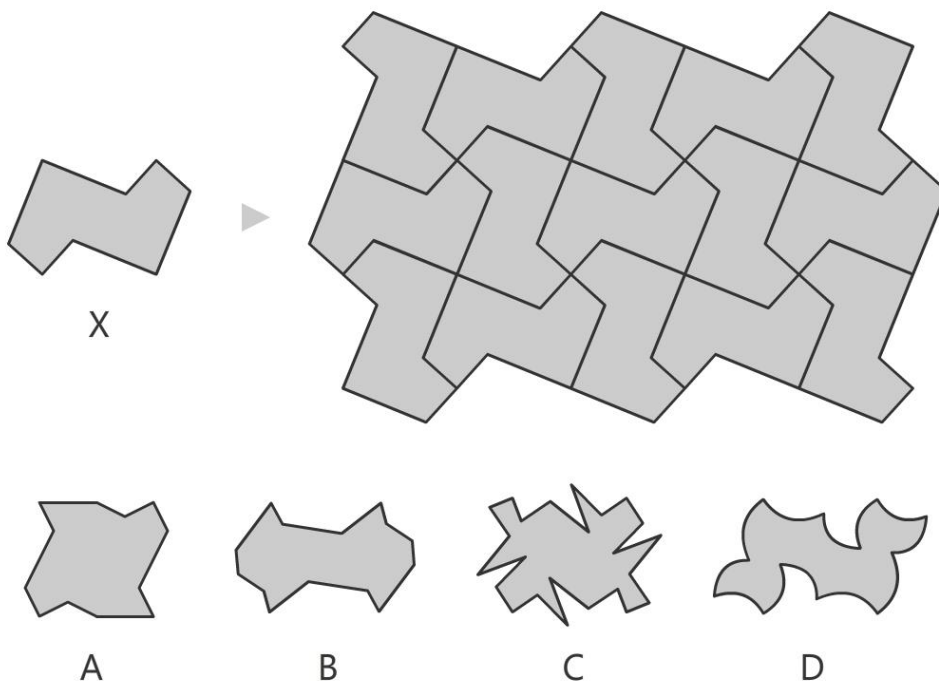

Q.22 Which of the following statements related to Indian musicians is/are TRUE?

- A. Ustad Allah Rakha and Ustad Zakir Hussain are known for playing the Tabla
- B. Pandit Nikhil Banerjee and Ustad Vilayat Khan are known for playing the Sitar
- C. Ustad Ali Akbar Khan, Ustad Amjad Ali Khan and Dr. L. Subramaniam are known for playing the Violin
- D. Pandit Ravi Shankar and Pt. Hariprasad Chaurasia are known for playing the Shehanai

Q.23 Which of the options on the right can be formed by folding the profile shown on the left?

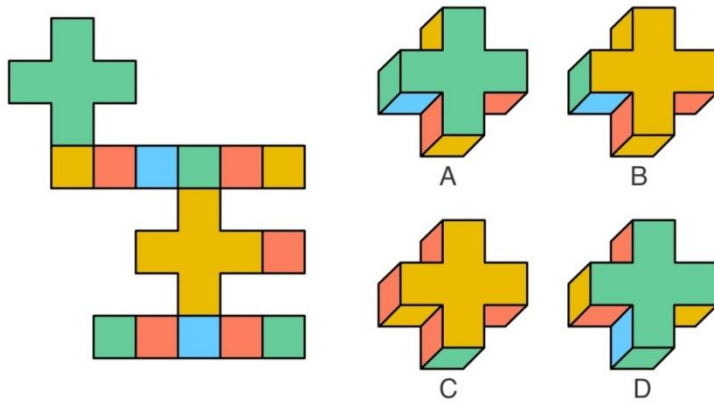

Q.24 In a 3D structure made of cubes of equal size, an L shaped hole is made by removing a few cubes, as shown on the left. Which of the 3D structures in the options on the right would successfully pass through the L shaped hole, given that they are also made of cubes of same size?

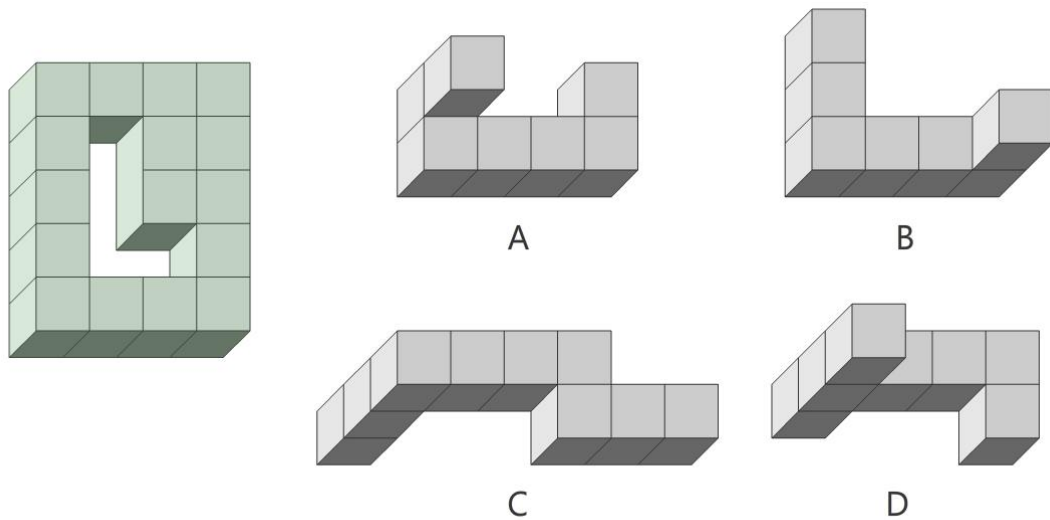

Q.25 The figure given below shows six bar charts corresponding to the volume of agricultural produce from farms of various farmers. The actual quantities are also shown in the figure. Red bars indicate tomatoes, green bars indicate leafy vegetables, and blue bars indicate berries. Assume that they have seen each other's bar charts. Who can correctly make at least one of the following statements?

(i) Everyone who produced any one item more than what I produced, she also produced every other item more. (ii) Everyone who produced one item less than what I produced, she also produced at least one other item less.

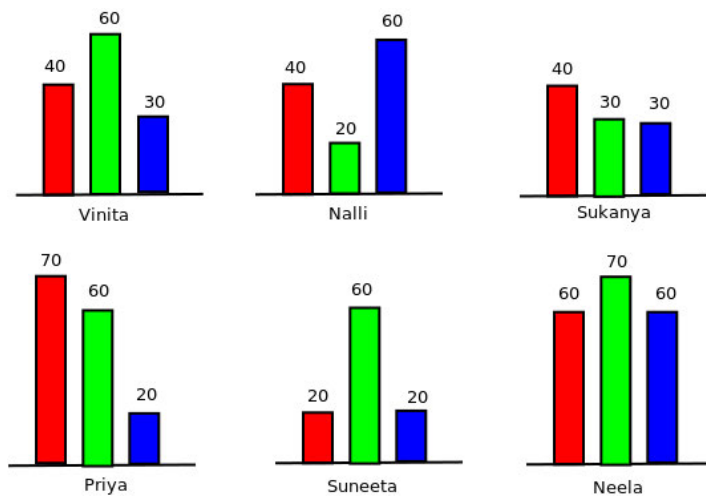

- A. Vinita
- B. Priya
- C. Neela
- D. Suneeta

Q.26 The figure shows four road networks. Which of these four road networks can be traversed by a traveller, such that the following challenge can be satisfied: "The traveller must cover all the roads in the network. She is allowed to visit a city more than once, but she is not allowed to travel on any road more than once. Also, the traveller must come back to the city where she starts."

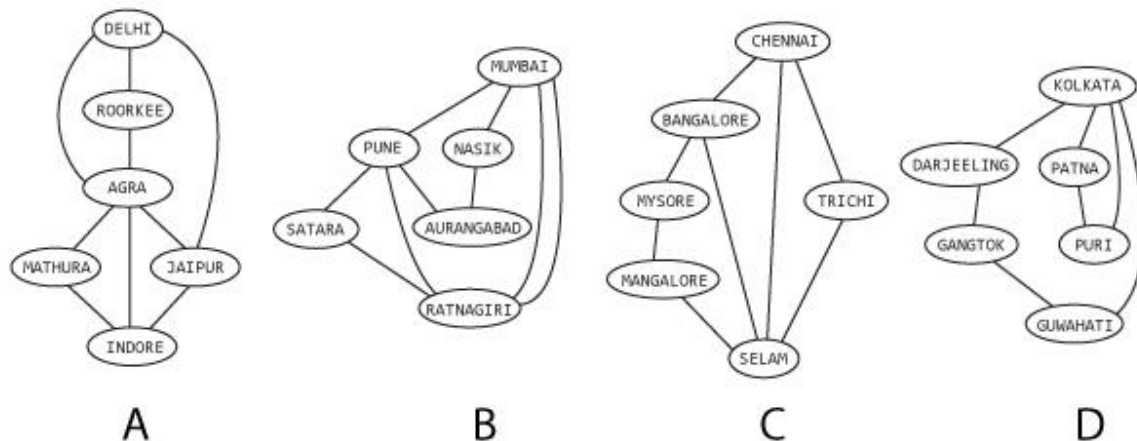

Q.27 The grid of squares shown in the figure is to be tiled (covered with tiles) with the tiles shown in the options. The covering tiles must not overlap and should not have gaps around them. Only four squares in the middle are not to be tiled. Once a tile is chosen, other tiles must be of that type only. Tiles can be flipped and rotated if required. Which of the tiles can be used to tile the given grid?

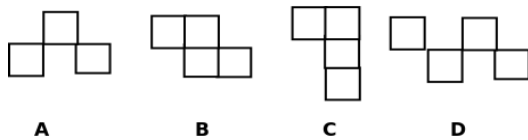
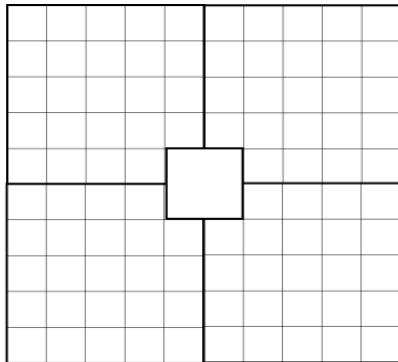

Q.28 Suresh, Biju and Tina bring one gift each. When they meet, they swap their gifts in such a way that no one gets back what they had brought with them. The gifts are, a book, a pen, and a ball.

Suresh says: I gave my gift to the one who gave away the ball.

Biju says: I received my gift from the one who gave gift to the one who gave away the ball.

Tina says: I got what I always wanted.

Biju says: But Tina, you had to give away your pen.

Which of these statements is/are TRUE?

- A. Tina gets the Ball
- B. Tina gets the Book
- C. Suresh gets the pen
- D. Biju gets the Book

Q.29 If the geometric solid blocks shown below, are cut along a single flat plane, which of these can have the cross section of a regular hexagon (all sides equal)? Assume, all blocks are extruded from polygons with sides of equal length.

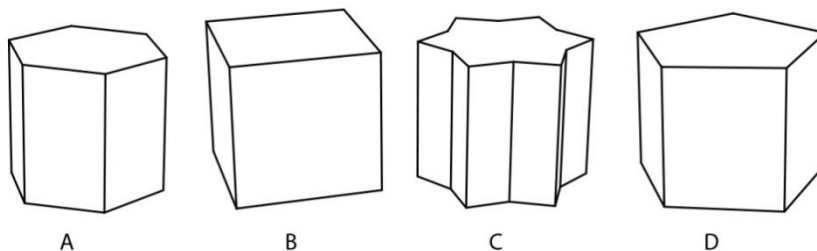

Q.30 The following patterns are made on a wall by using ceramic tiles. Which of the given patterns is/are made from a single type of tile?

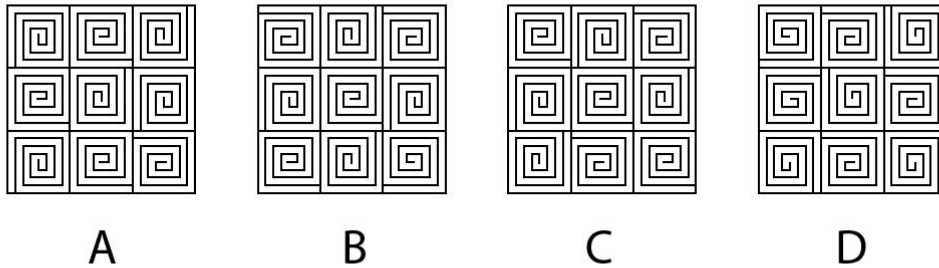

Q.31 Which of the following statements about the areas of Indian states is/are TRUE?

- A. Arunachal Pradesh is larger than Kerala
- B. Punjab is larger than Assam
- C. Chhattisgarh is larger than Jharkhand
- D. West Bengal is larger than Uttarakhand

Q.32 Image P shows a portion of a larger photograph. Some operations have been done on that photograph using an image manipulation software. Image Q shows a portion of the resulting photograph. Identify the option(s) that specifies/specify the correct operations.



- A. Rotate clockwise by 90 degrees, flip horizontally, then rotate clockwise by 90 degrees
- B. Rotate clockwise by 180 degrees, then flip horizontally
- C. Rotate clockwise by 180 degrees, then flip vertically
- D. Rotate clockwise by 90 degrees, flip vertically, then rotate clockwise by 90 degrees

Q.33 Which of the following birds is/are native to (found in) India?



A



B



C



D

Q.34 The word given below uses a particular font. Which option(s) belongs/belong to the same font?

Soulful

2

A

3

B

6

C

5

D

Q.35 A set of two frames with square openings when perfectly overlapped with each other allow light though it in certain patterns. Shown below are four sets of such frames. These frames are either hinged (A and B) or pivoted (C and D) to each other. Assuming that the red frames are fixed and the blue frames are allowed to move, which option(s) will allow light to pass through as in the pattern shown on the left?

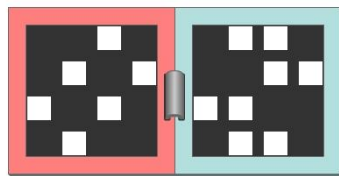

A

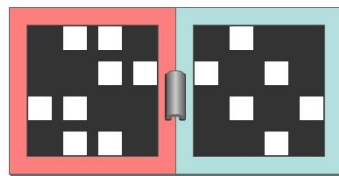

B

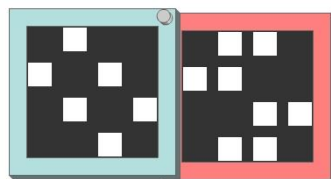

C

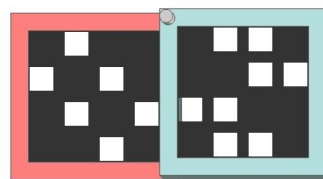

D

Q.36 Refer to the tools below and read the statements. Based on what you can see, which of the following options is/are correct?



- A. All tools have atleast one common working principle
- B. All of them can be used for cutting fabric
- C. Only one has spring back element, at least one has provision to crack nuts
- D. Three of them have a provision to crack nuts

Q.37 Multiple pages of a book are often printed on a single sheet. The sheet is later folded and cut appropriately to get the pages in a correct sequence and orientation. Mistakes happened while printing this particular 16 page booklet. The sheet was printed with pages numbered and oriented as shown on the left. The sheet was folded and cut in the sequence as shown on the right. Given this, which of the options is/are TRUE about the final booklet?

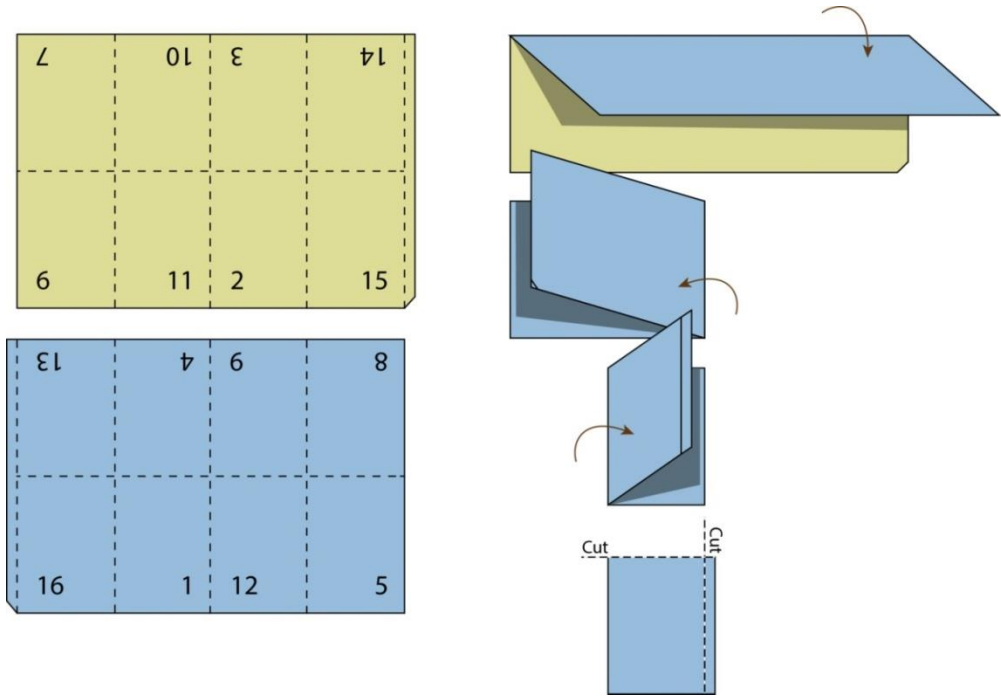

- A. Page 13 appears before page 10
- B. Page 11 is the last odd-numbered page
- C. Page 4 is the first even-numbered page
- D. All pages appear in the correct orientation

Q.38 A bag contains 20 socks, of which 10 are white and 10 are black. If the socks are drawn without replacement, which of the options is/are TRUE?

- A. If 1 sock is drawn at random, the chance that it is white is 50%
- B. If 2 socks are drawn at random, the chance that both of them are the same colour is 50%
- C. If 3 socks are drawn at random, the chance that at least two of them are the same colour is higher than if only 2 socks are drawn at random
- D. If 4 socks are drawn at random, the chance that at least two of them will be the same colour is higher than if only 3 socks are drawn at random

Q.39 In the figure below, a person is putting small packets of potatoes in one of the bins A, B or C. The packets are placed on a table, and the bins A, B and C are placed on tables which are lower in height as compared to table on which the packets rest. Which of the following statements is/are TRUE?

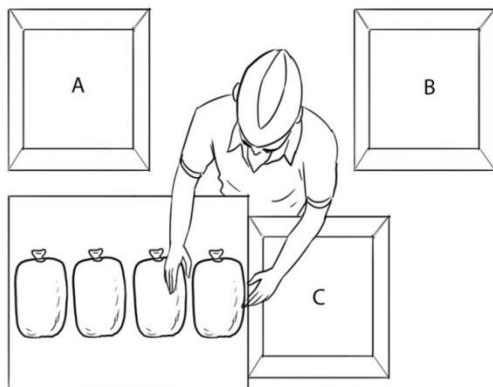

- A. Lifting the bag from the table and placing it in bin B will be less effortful compared to lifting and placing it in bin C
- B. Lifting the bag from the table and placing it in bin A will be more effortful compared to sliding it in bin C
- C. Lifting the bag from the table and placing it in bin B will be less effortful than sliding it to bin C
- D. Sliding the bag from the table to bin C will be less effortful than lifting it and placing it in bin C

Q.40 In a town, there are four kinds of persons: Mizrabs, Frets, Dictions and Scripts. People of any given kind play exactly two musical instruments. An instrument is played exactly by people of two kinds. Some Mizrabs play Tabla. Some Frets play Sitar. The kind that plays Harmonium does not play Sarod. The kind that plays Tabla does not play Sitar. Mizrabs and Dictions do not play the same instrument. Frets and Scripts do not play the same instrument. Dictions do not play Harmonium.

Which of the following is/are TRUE?

- A. Frets do not play Tabla
- B. Scripts play Tabla
- C. Mizrabs play Harmonium
- D. Dictions play Sitar

Section C: Multiple Choice Questions

Section C (180 Marks) contains a total of 45 Multiple Choice Questions (MCQ). Each question has four choices out of which ONLY ONE is the correct answer. There is NEGATIVE marking for this section. Each correct answer will be awarded 4 marks and each wrong answer will receive -1.32 (minus one point three two) mark. Questions not attempted will be given zero mark. Questions from 41 to 85 belong to this section.

Q.41

ඡත්තීස්ගඪ් = Chhattisgarh

කේරල = Kerala

පන්ජාබය = Punjab

ගුජරාතය = Gujarat

Maharashtra = ?

A. තමිල්නාඩුව

B. රාජස්ථාන්

C. ක්‍රිෂ්ණාප්‍රා

D. මහාරාෂ්ට්‍ර

Q.42 The word given below uses a particular font. Which option belongs to the same font?

ප්‍රසිද්ධ

ව ව ව ව

A

B

C

D

Q.43 Which option will replace the question mark?

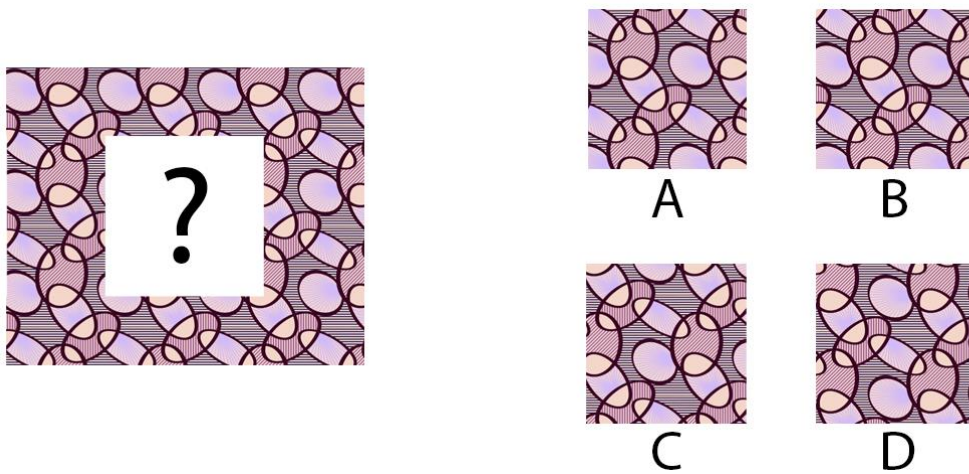

Q.44 An envelope made of a single piece of paper is taken, and a few cuts are made on it. The envelope and the cuts are shown below. Identify the resulting figure when the envelope is unfolded?

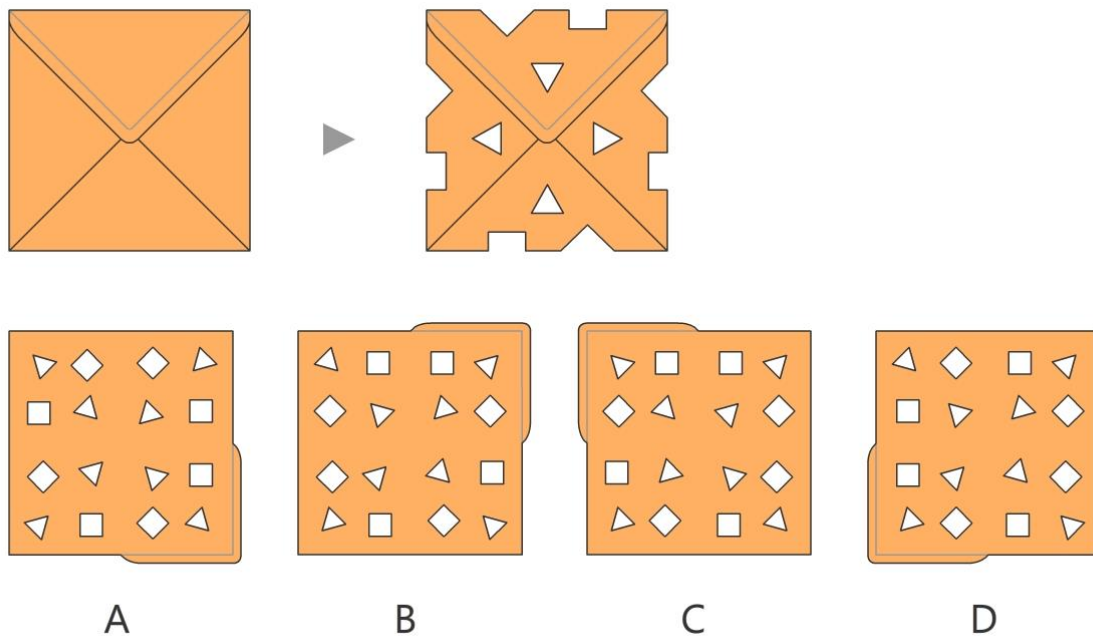

Q.45 Shown in the four figures A, B, C, and D on the right, are broken lines drawn on a transparent sheet. Each figure is folded over along the dotted lines as shown. Identify the correct option that will generate the motif shown on the left.

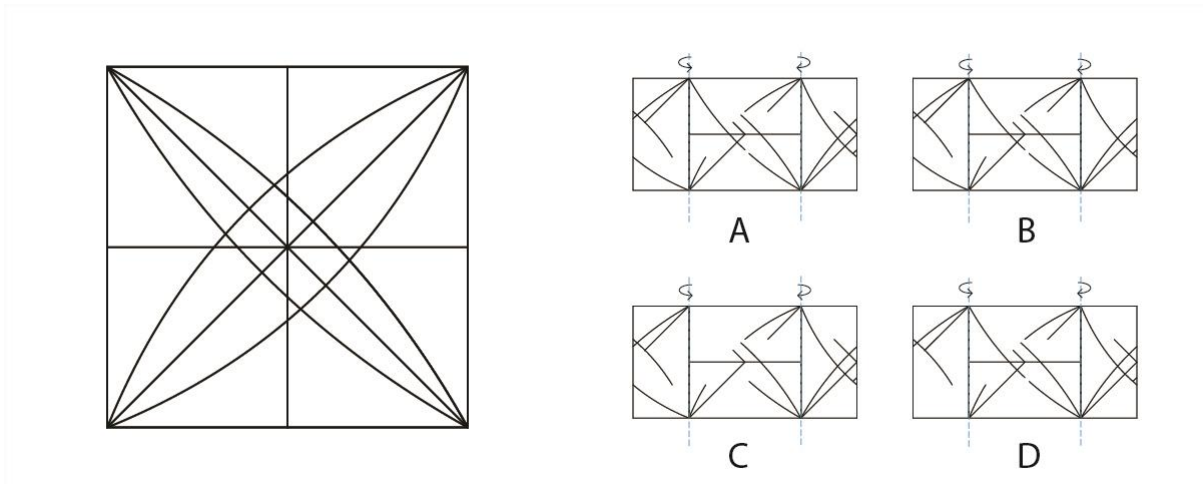

Q.46 A light source is attached to a rod fixed in the centre of the ceiling of a square room. This source rotates 360 degrees with the rod as its axis. This source projects a red beam of light onto the four walls of the room. This setup is shown in the isometric view and the side view in the figure below. Identify the correct path of the beam of light on the four walls of the room.

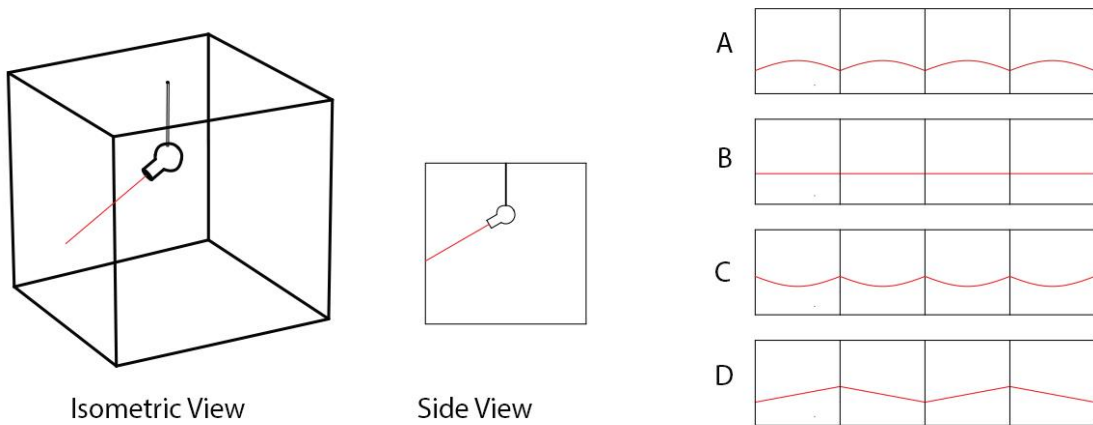

Q.47 The figure below shows the top view, the front view, and the side view of a three-dimensional solid object. What is the minimum number of surfaces that a solid with these views, can have? Assume that there are no hidden lines.

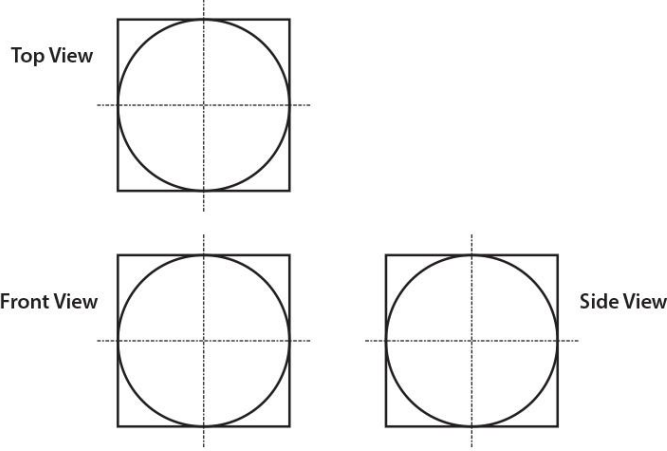

- A. 12
- B. 14
- C. 16
- D. 30

Q.48 Sheetal is running. Which option denotes the most natural pose?

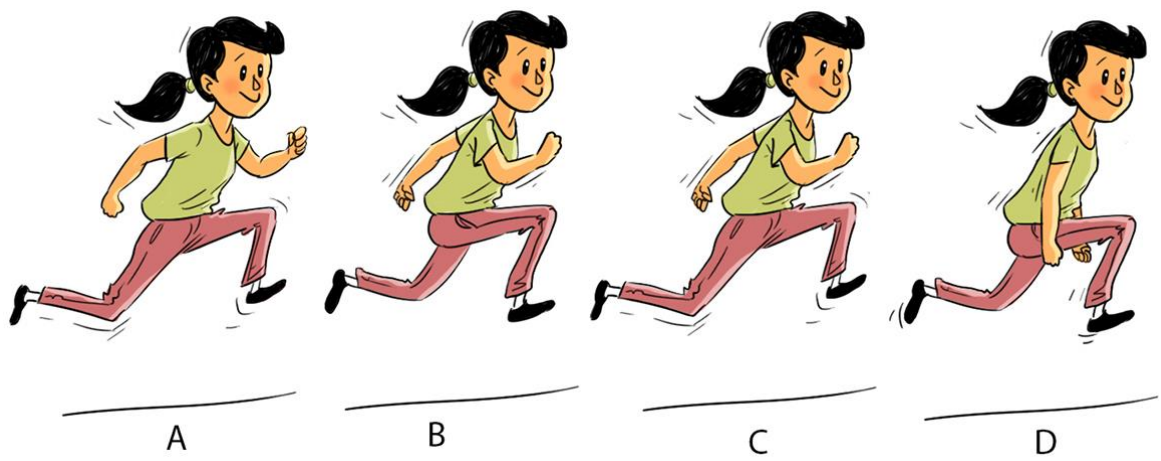

Q.49 Identify the correct profile of the cricketer that corresponds to the given front pose.

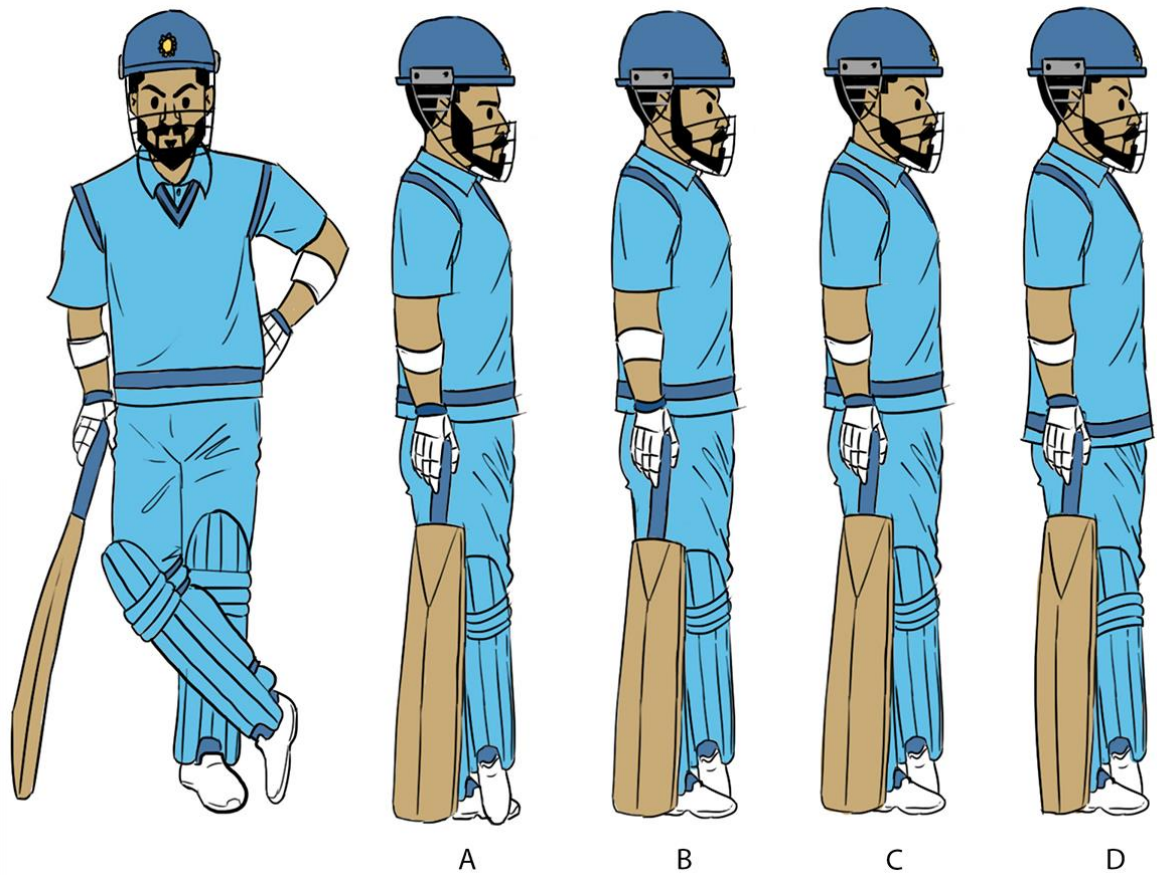

Q.50 Seema on the left, is looking at a mirror. Which option shows her reflection correctly?



Q.51 Kavita is holding a lit torch below her face as she narrates a ghost story to her friends in a dark room. Which option shows the lighting correctly?

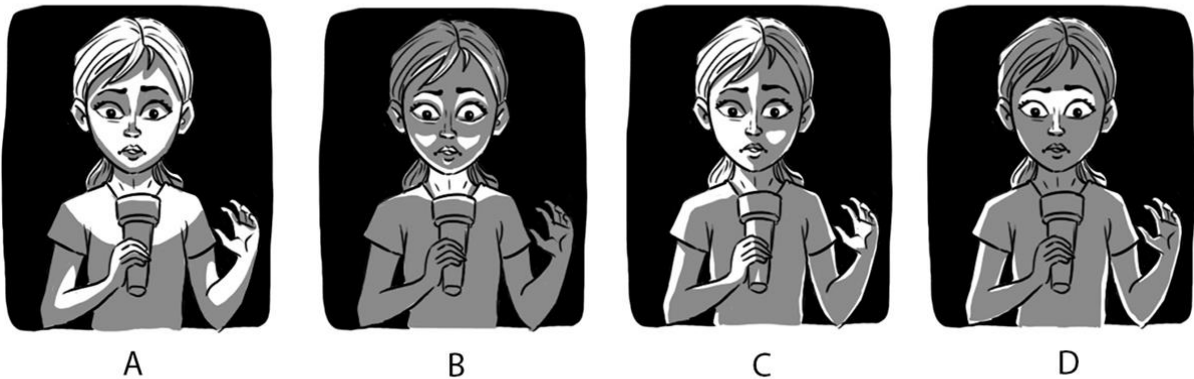

Q.52 Which option correctly represents the top view for the given perspective view?

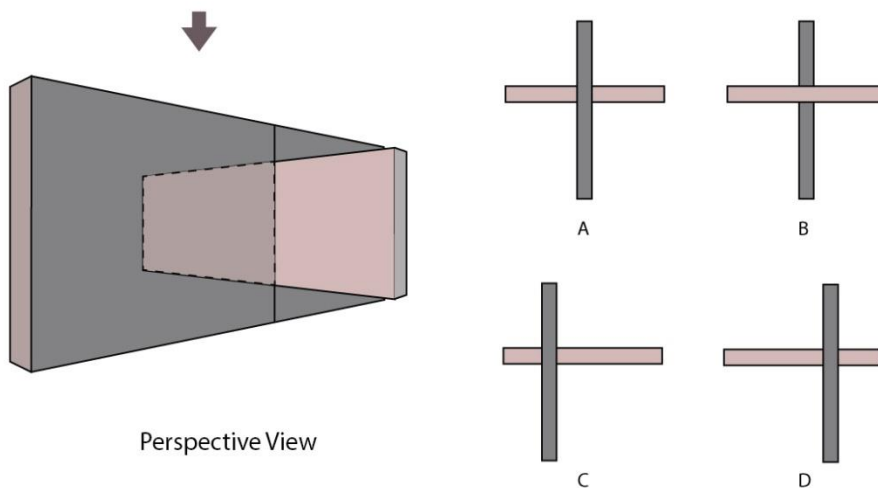

Q.53 A milkman is returning from his trip on his bicycle. He has two empty containers of 5 litres and 3 litres hanging on one side of the bicycle, and a full 8 litres milk container on the other side. He was not able to ride the bicycle properly. So he stopped and decided to distribute the milk, so that the load becomes balanced on the both sides of the bicycle. Unfortunately he has forgotten his measuring cup on his last stop.

How many minimum turns will it take for him to be able to distribute the milk into two equal halves to balance the load? Ignore the weight and other material properties of the containers and the bicycle.

- A. 6
- B. 7
- C. 8
- D. 9

Q.54 Four students P, Q, R and S are shown a box which contains a few white balls, and a few red balls. Their teacher asks each of them individually to make a statement. The teacher knows that exactly one of them is a liar and others are not. From the statements that they make, the teacher is able to find out who the liar is. Given below are the statements made by the students. Who is the liar?

P says: There are equal number of red balls and white balls.

Q says: P is a liar and there are 3 red balls and 2 white balls.

R says: Q is not a liar and there are some red balls and some white balls in the box.

S says: R is not a liar.

- A. P is the liar
- B. Q is the liar
- C. R is the liar
- D. S is the liar

Q.55 Shown below is an image with straight lines, in which, a tilted-square has been cut out. From the given options identify the missing cut out of the square that completes the original image.

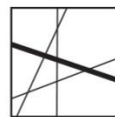
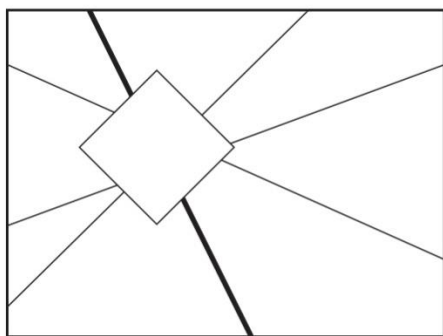

A



B



C

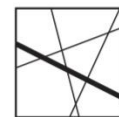

D

Q.56 A T-shirt with folding marks and the folding sequence is shown on the left. The folding is done backwards and perfectly along the lines. After completing all the folds, the T-shirt is then turned around. Identify the correct folded T-shirt from the options on the right.

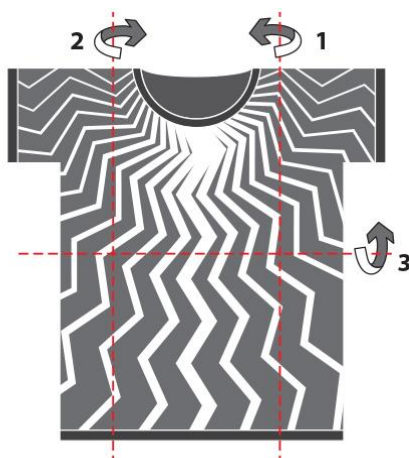

A



B



C



D

Q.57 A paper strip is rolled and then punched by a triangular punch, as shown below. After unrolling the paper strip, what would be the pattern of holes on the paper?

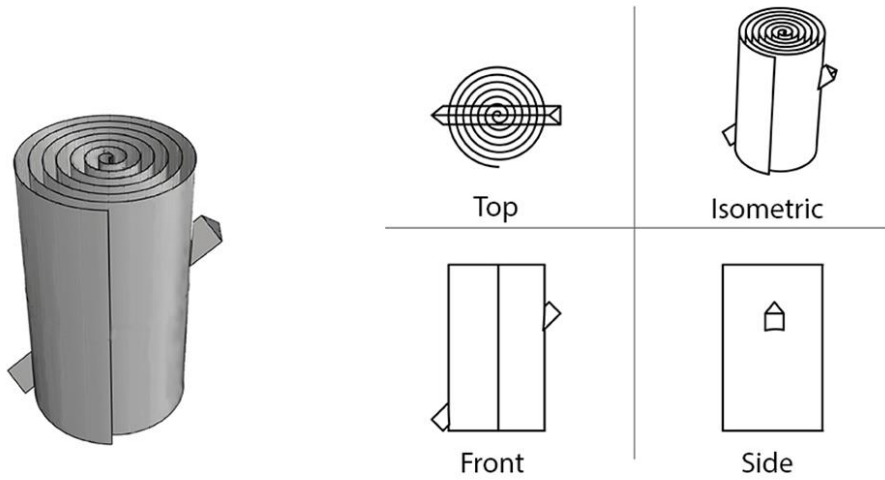

- A**
- B**
- C**
- D**

Q.58 Identify the option that will replace the question mark.

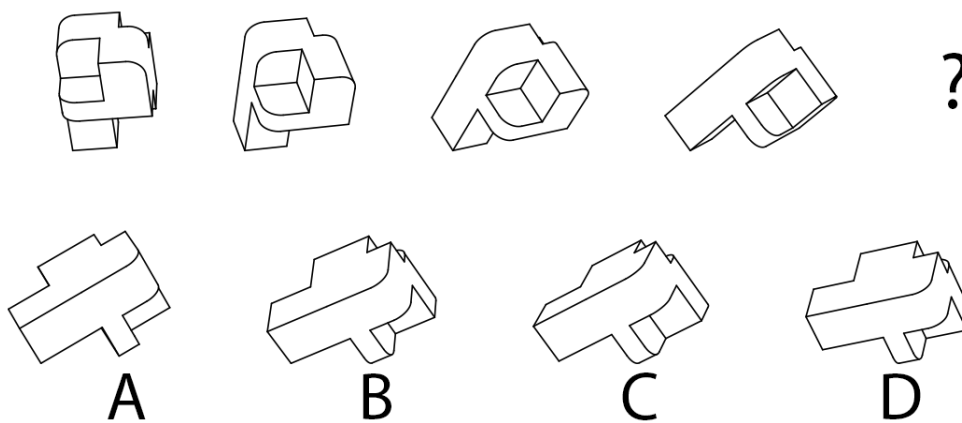

Q.59 How should the two solids be joined in order to form a tetrahedron?

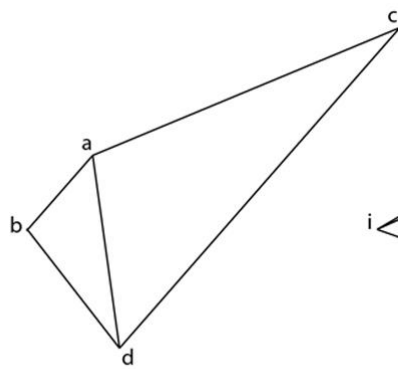

Fig 1

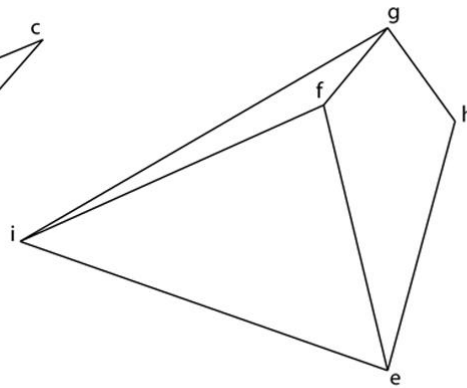
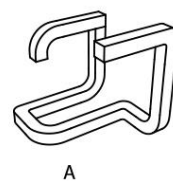
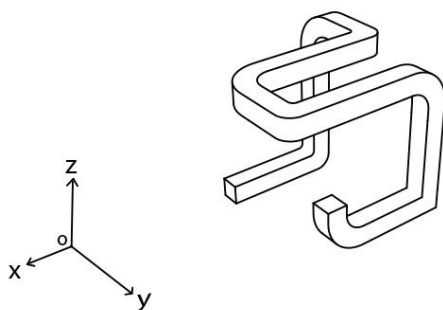

Fig 2

- A. ci, ag, be
- B. af, bg, ci
- C. ae, ci, bf
- D. ci, ae, dh

Q.60 Perspective view of an object is shown below. The object is rotated 180 degrees around y-axis (when viewed from a point on the positive y-axis towards the origin) and then similarly rotated 180 degrees around z-axis. Which of the following perspective view options will be the result of the rotations? Assume positive x and y axes point in the direction of the viewer.



A

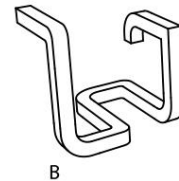

B

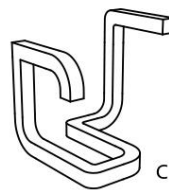

C

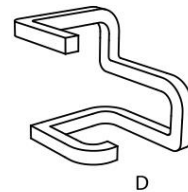

D

Q.61 On a glass entrance door of a building, there is an arrow sign pointing towards the newly shifted office space on the first floor. The sign is printed on a paper and pasted on the outside of the door using two tapes, one at the top-middle, and other at the bottom-middle. Due to the frequent use of the door, the top tape is peeled off, and the paper falls with the bottom tape holding it. After falling, from inside the building one can see the arrow sign pointing towards the Southwest direction. If that is the case, in which direction was the arrow sign originally pointing to (as seen from outside)?

- A. Southeast
- B. Northeast
- C. Northwest
- D. North

Q.62 A cube and a truncated cone are shown below. The cube has dimensions $10 \times 10 \times 10$ units. The truncated cone has a base diameter of 12 units, height of 11 units and top diameter of 6 units. Imagine these two solids are intersecting while positioned coaxially on the same base. Further imagine the cube vanishes completely along with the intersected portion of the truncated cone. What remains?

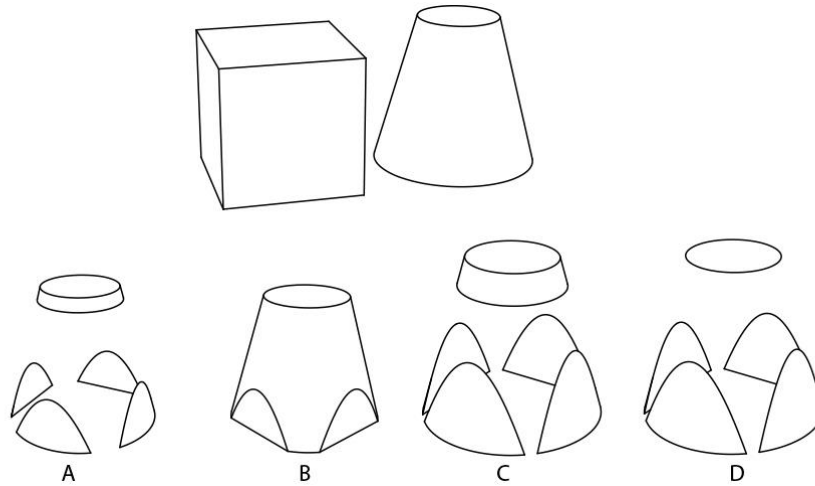

Q.63 Afreen is a teacher. She decides to give biscuits to her students Javed, Jai, Joshua and Jaspreet. She has biscuits of four different sizes, all of which have the same perimeter and thickness. The proportions of the biscuits are shown below. She asks Javed, Jai, Joshua and Jaspreet, in that order, to pick biscuits in descending (largest to smallest) order of volume. Which biscuits should Jai and Jaspreet pick up respectively?

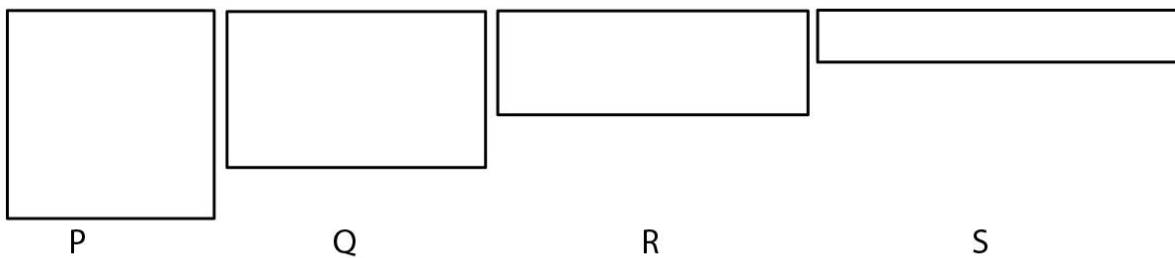

- A. Q and R
- B. P and S
- C. Q and S
- D. P and R

Q.64 A crocodile at point P sees four meatballs at A, B, C and D across the river. The crocodile moves with the same speed on ground as well as in water. If the speed of river is half the speed of crocodile, which meatball can it catch in the shortest time?

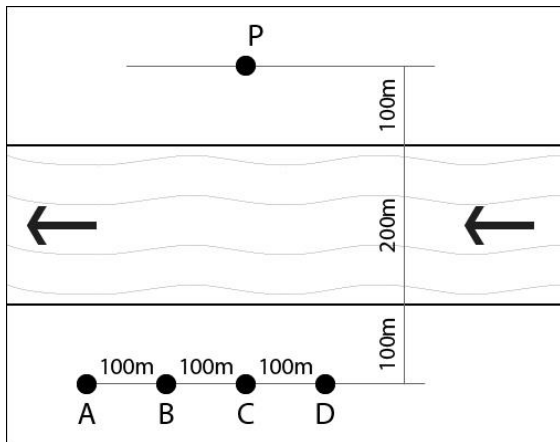

Q.65 Which number will replace the question mark?

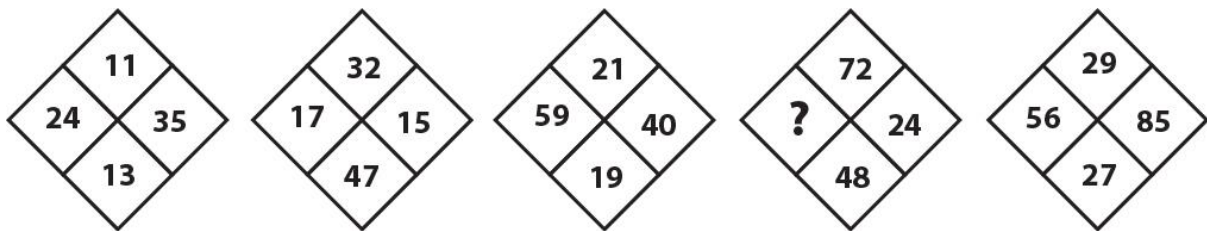

- A. 21
- B. 24
- C. 28
- D. 30

Q.66 Which black shape from the options will match the white shape in the figure, using simple rotation.

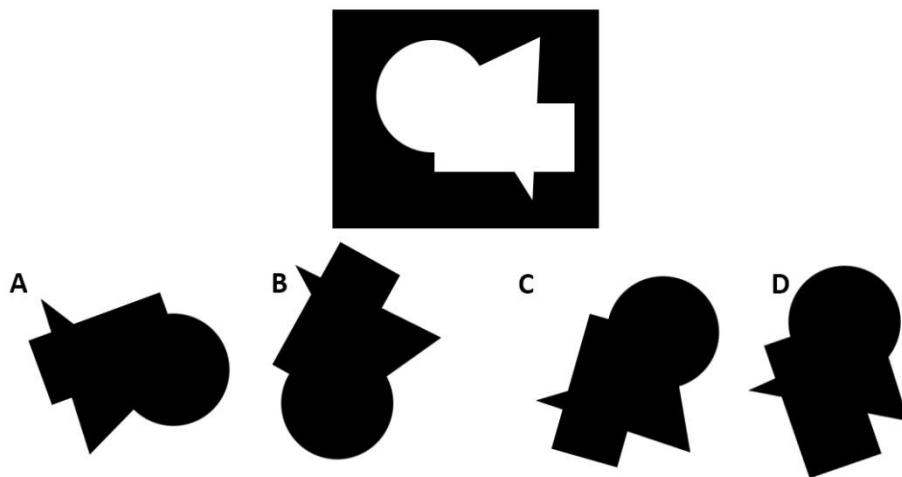

Q.67 The figure below shows a 3×3 cube with 4 colours. The same coloured shapes are detached and shown separately for reference. Identify the shape of the red block from the given options.

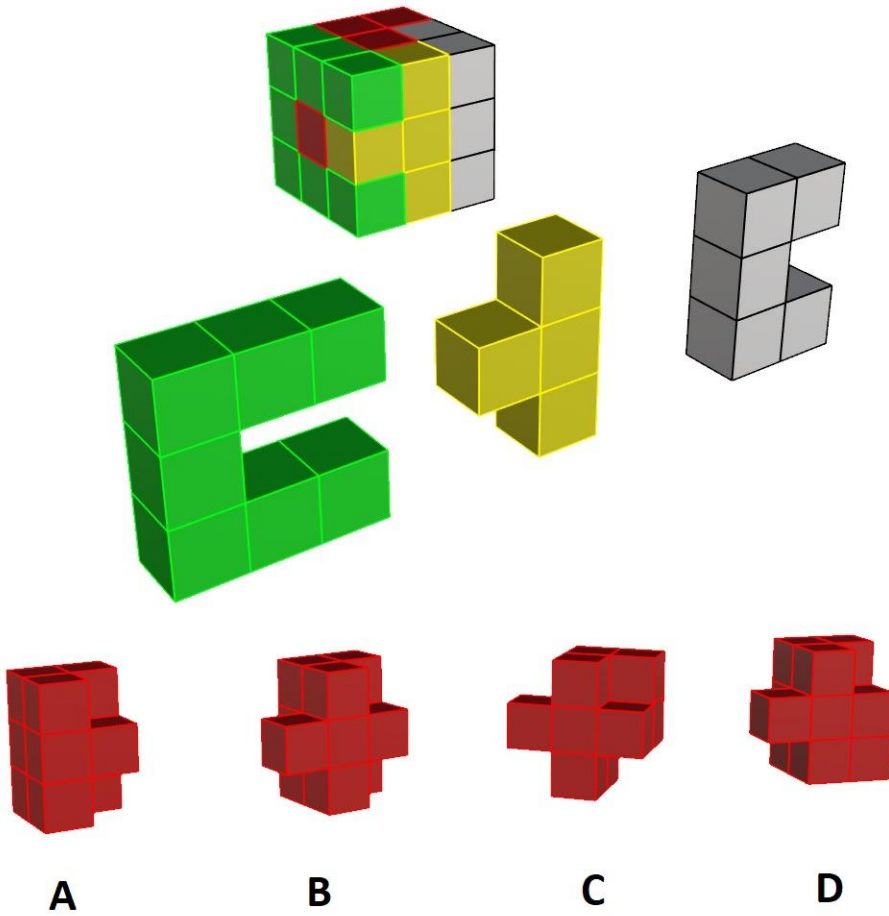

Q.68 Which option will replace the question mark?

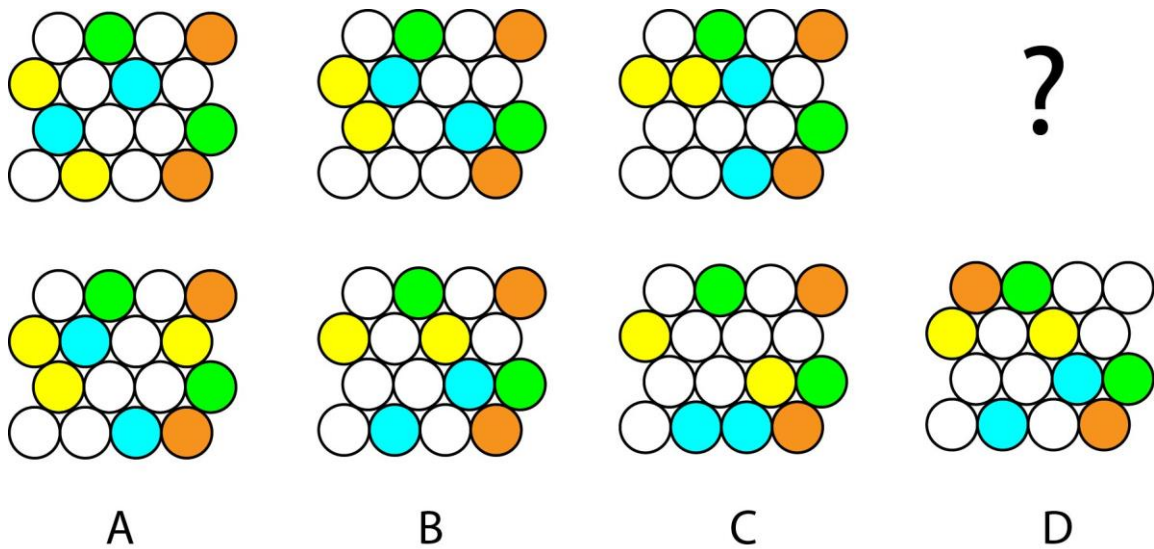

Q.69 Jaya, Sushama, Rama, Dilip, Sudhir and Arun are doctors working in a hospital specialising in gynaecology, neurosurgery, paediatrics, orthopaedics, anaesthesia and intensive care, not necessarily in that order. What is Rama's specialisation if the following conditions are to be met:

- Jaya, Arun and Sushama work together.
- Neurosurgeons always need the help of orthopaedic surgeons in the operation theatre.
- Orthopaedic surgeries cannot happen on the same days that gynaecological surgeries happen.
- Gynaecologists need paediatricians on standby during their operating hours.
- Though Sudhir and Dilip work together, neither has ever met Sushma in the hospital.
- All specialisations except intensive care need to work with Arun, the anaesthetist.
- Doctors don't work together other than as mentioned above.

- Neurosurgery
- Intensive care
- Orthopaedics
- Paediatrics

Q.70 Shown below on the left is a Ferris wheel which is not in motion. A photographer has clicked a photograph of the Ferris wheel while it was rotating at its maximum speed in an anti-clockwise direction. Which of the options below is the image that he has captured?

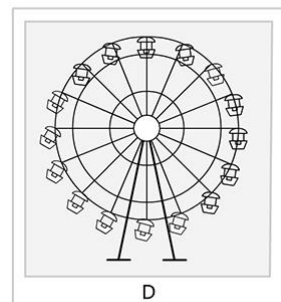
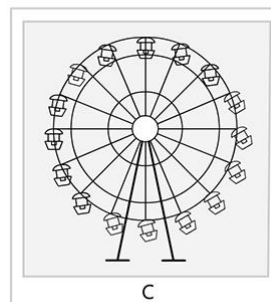
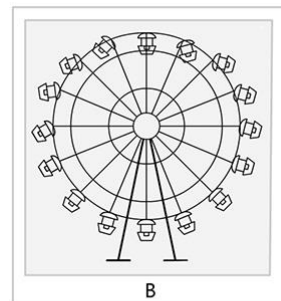
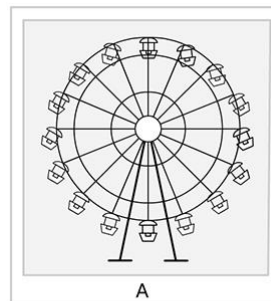
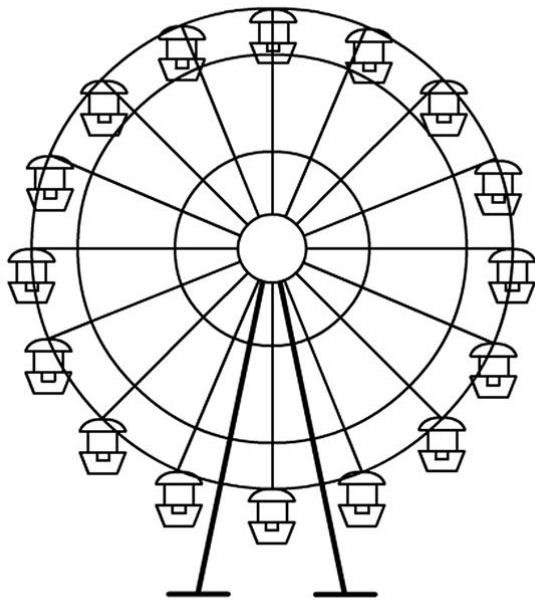

Q.71 Which option will replace the question mark?

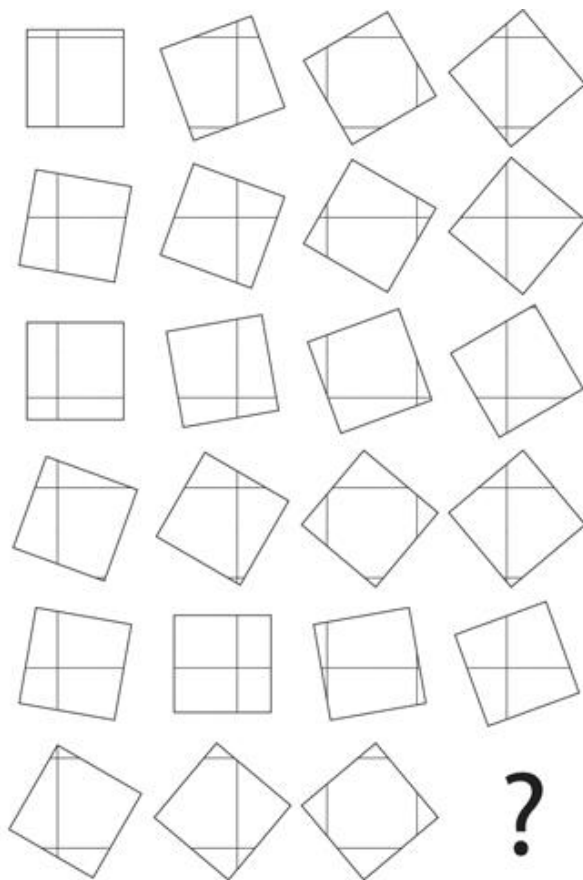

- A.
- B.
- C.
- D.

Q.72 Identify the correct order of rotation.

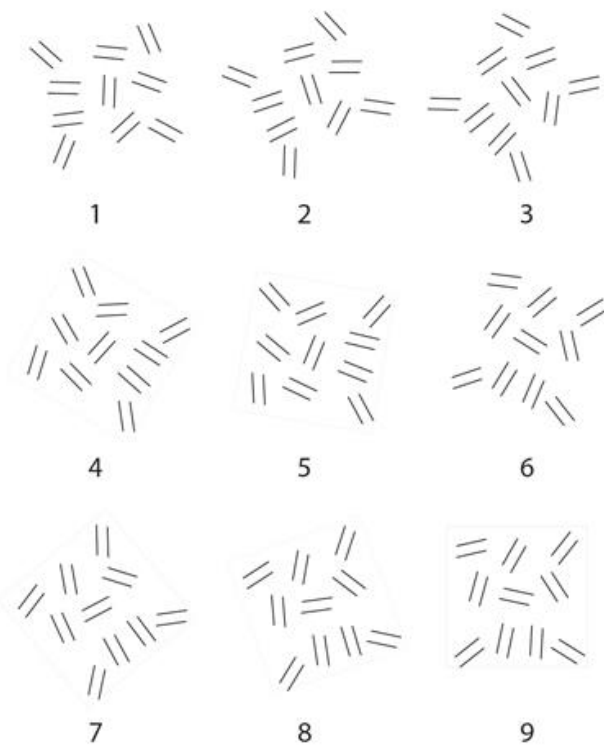

- A. 789654123
- B. 123698745
- C. 147852369
- D. 963258741

Q.73 The following images are iconic art forms/products of certain countries. Identify the correct set of countries they all can be predominantly attributed to. The individual countries in each set are in a random sequence.



- A. India, Turkey, Mongolia, Russia
- B. Mongolia, Burma, Afghanistan, India
- C. India, Russia, Japan, Turkey
- D. Pakistan, Japan, India, Mongolia

Q.74 Refer the following images of a metal artefact made using traditional manual tools, skills and processes. Identify the correct set of operations required to make it.



- A. Forging, Bending, Punching, Twisting
- B. Casting, Bending, Punching, Twisting
- C. Twisting, Drilling, Punching, Bending
- D. Bending, Casting, Forging, Punching

Q.75 Refer to the chairs shown below. Which of the following options is TRUE?



- A. P is most stable in terms of centre of gravity and R is made of least number of visible parts
- B. S is made of least number of visible parts and Q is most stable in terms of centre of gravity
- C. P is most stable in terms of centre of gravity and S is made of least number of visible parts
- D. R is ergonomically comfortable and Q is most stable in terms of centre of gravity

Q.76 Refer to the following image of a wooden product and read the statements below.

1. It has provision for cracking nuts, and it has a good grip
2. It has a good grip, and it has provision for opening cans as well as cracking nuts
3. It has provision for a grinding nuts, and its making involves drilling, twisting, and casting
4. Its making involves drilling, turning, and twisting

Which of the following options is correct?



- A. 1 is true, 2 and 3 are false
- B. 2 is true, 3 and 4 are false
- C. 3 is true, rest are false
- D. 4 is true, 1 and 3 are false

Q.77 Shown is a quadrant that is mirrored first on x-axis and then on y-axis. Identify the correct complete figure from the given options.

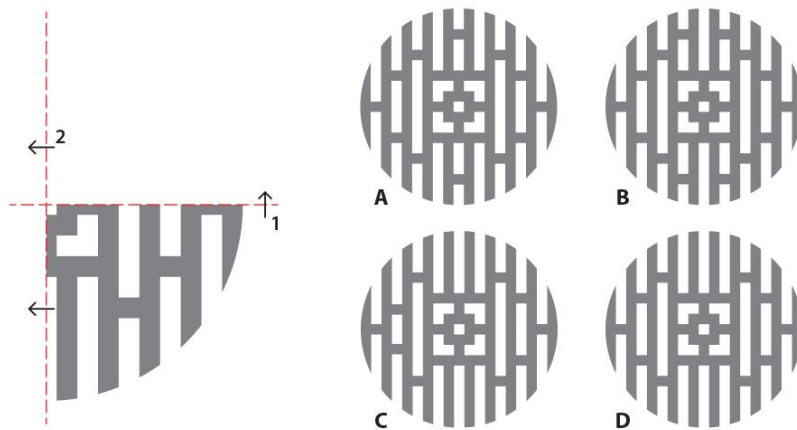

Q.78 Thamarai's father has made a roti for her lunch. She folds the roti in the following sequence and packs it into her lunch box. Identify the folded roti.

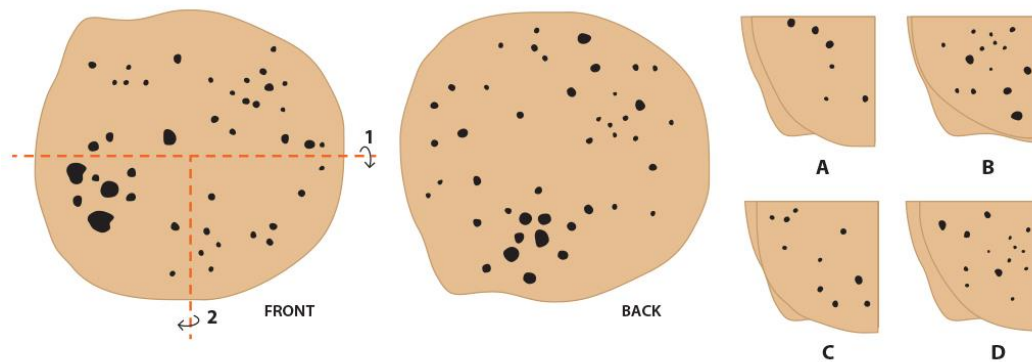

Q.79 An unwrapped cube is shown below. This cube has cuts of specific shapes on all sides. When the cube is folded, what would be the view as seen from direction X?

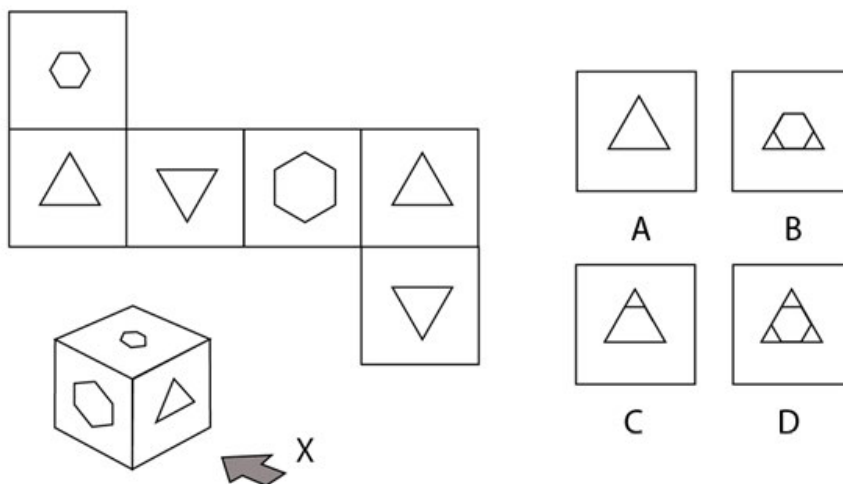

Q.80 The four figures below show a hand gripping a cylinder. In which of these figures, will the grip exert the maximum force?

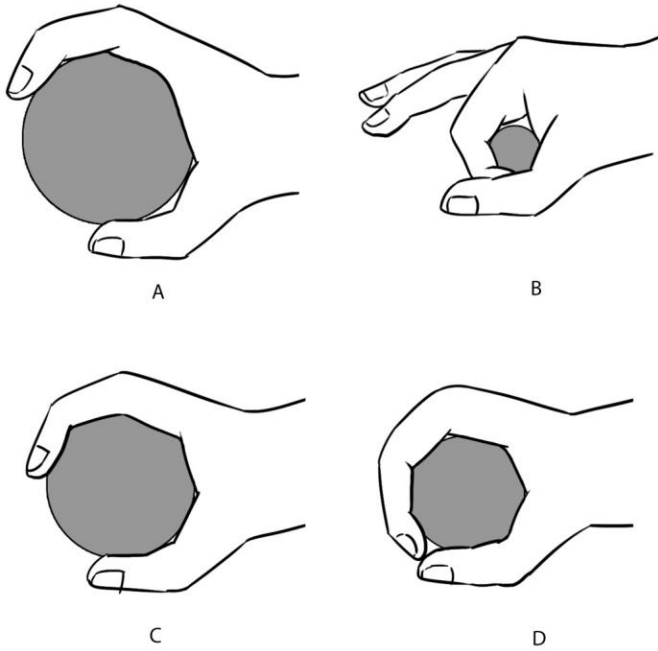

Q.81 Four cut-outs of shapes (labelled p, q, r, s) are shown below. Using one or more of the cut-out pieces, how many unique combinations can be made that will create a square/rectangle?

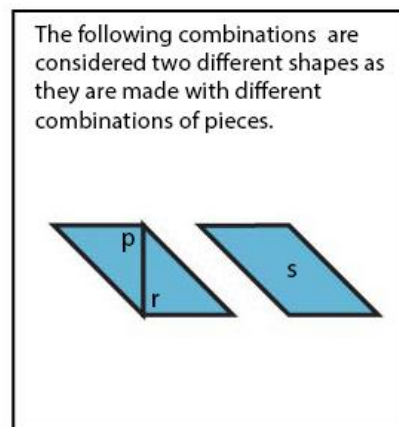
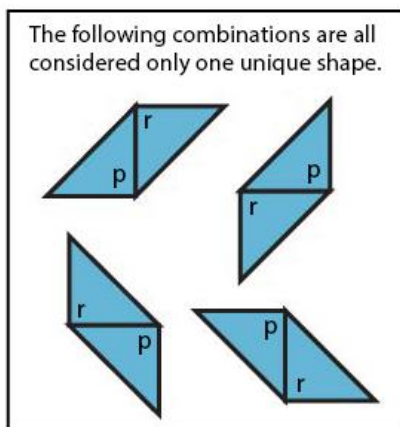
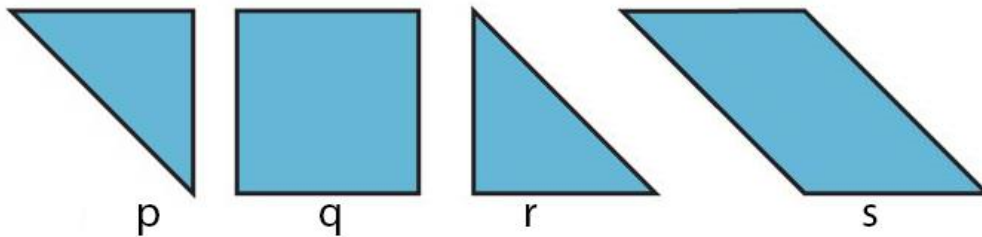

- A. 4
- B. 5
- C. 6
- D. 3

Q.82 The figures show simplified shapes of the neck portion of the vertebral column of a horse. Which of the options is most correct?

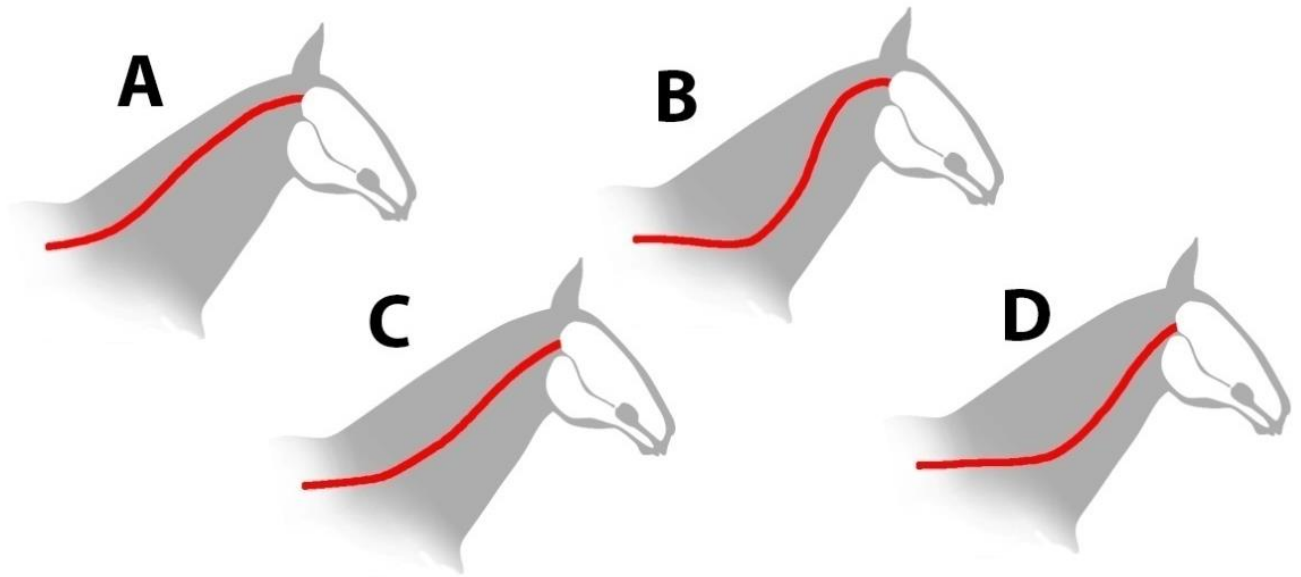

Q.83 How many times is the area of the outermost triangle compared to the area of the innermost triangle?

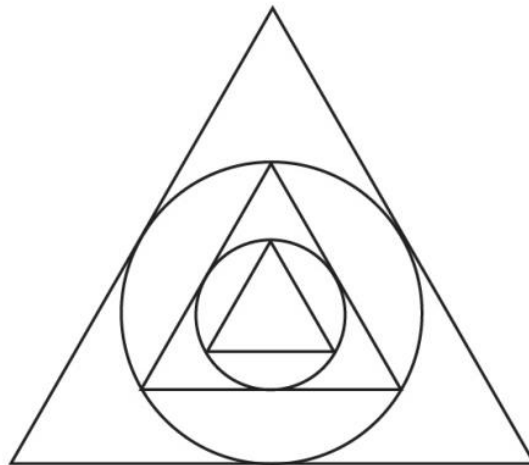

- A. 16
- B. 9
- C. 9.42
- D. 12

Q.84 Which option will replace the question mark as the frog jumps in an animation sequence?

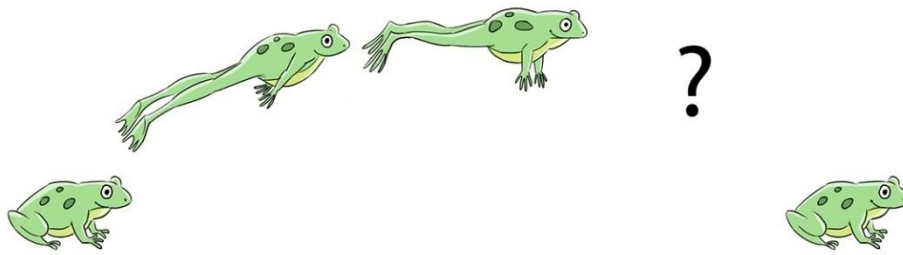

A

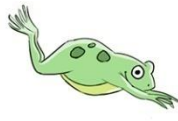

B

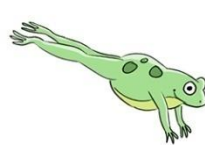

C



D

Q.85 Which option will replace the question mark?



A



B



C



D

UCEED 2019 Final Answer Key

The sequence of these Answer Keys corresponds to the sequence of questions in the Question Paper uploaded on the UCEED Website.

Section A: NAT		Section B: MSQ		Section C: MCQ			
Question	Answer	Question	Answer	Question	Answer	Question	Answer
Q01	3	Q21	C D	Q41	D	Q61	B
Q02	22	Q22	A B	Q42	A	Q62	A
Q03	315 OR -315	Q23	B C D	Q43	B	Q63	C
Q04	44	Q24	A B C D	Q44	B	Q64	B
Q05	18	Q25	C	Q45	A	Q65	B
Q06	18	Q26	B D	Q46	A	Q66	C
Q07	20	Q27	C OR C D	Q47	B	Q67	B
Q08	7	Q28	A C D	Q48	C	Q68	B
Q09	9	Q29	A B	Q49	C	Q69	B
Q10	57	Q30	A C	Q50	C	Q70	D
Q11	10	Q31	A C D	Q51	B	Q71	D
Q12	450	Q32	B D	Q52	D	Q72	B
Q13	399	Q33	A B D	Q53	B	Q73	C
Q14	96	Q34	B D	Q54	A	Q74	A
Q15	24	Q35	A C	Q55	A	Q75	C
Q16	1190	Q36	A C	Q56	C	Q76	A
Q17	22 OR 23	Q37	A B D	Q57	D	Q77	D
Q18	9	Q38	A C	Q58	C	Q78	B
Q19	112	Q39	B D	Q59	B	Q79	D
Q20	160	Q40	A B C D	Q60	A	Q80	D
						Q81	B
						Q82	B
						Q83	A
						Q84	C
						Q85	A