

Distance & direction

(1-2) Directions: Answer the questions based on the information given below.

Eight persons are sitting at different places such that D is 6m north of A, who is 8m west of C. E is 12m east of B, who is 6m south of G. H is 4m south of C. F is 10m north of E. F is exactly between A and C.

1. What is the direction of C with respect to G?

- A -
South west
- B -
North east
- C -
North west
- D -
East

Solution

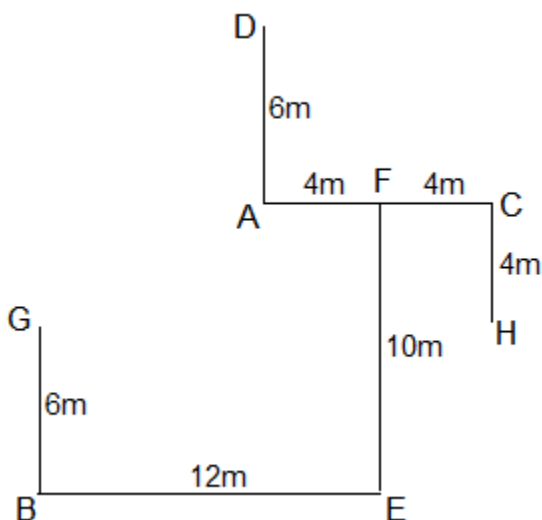

Wipro Elite NTH Reasoning Questions & Answers - Paper 4



C is to the north east of G.

Hence, option b.

2. What is the shortest distance between G and H?

A -

15m

B -

16m

C -

18m

D -

20m

Solution

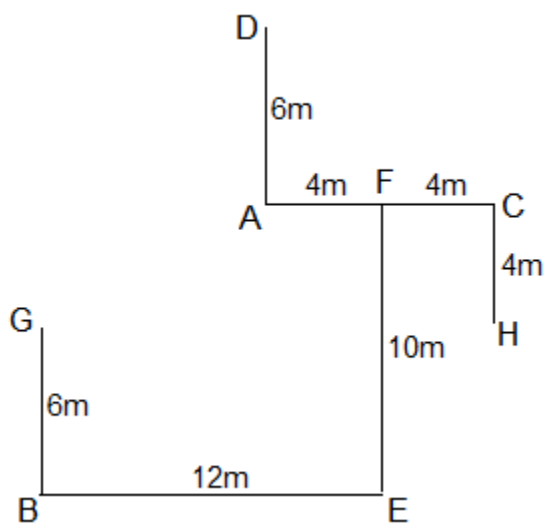

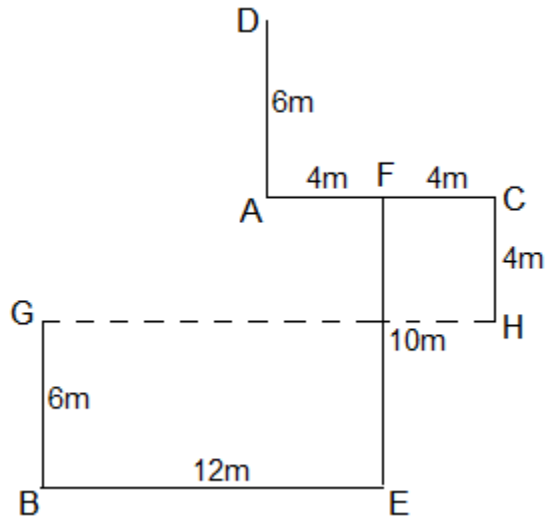

The shortest distance between G and H is $(12 + 4) = 16\text{m}$

Hence, option b.

Logical inequalities

3. In the question, assuming the given statements to be true, find which of the conclusion (s) among given three conclusions is /are definitely true and then give your answer accordingly.

Statements: $V < Q \leq D$; $A < V$; $R < D \geq S$

Conclusions:

I. $S < V$

II. $A < D$

III. $R < Q$

A -

Only conclusion II is true.

B -

Only conclusions I and II are true.

Wipro Elite NTH Reasoning Questions & Answers - Paper 4



C -

Only conclusions II and III are true.

D -

Only conclusion I is true.

Solution

Given statements: $V < Q \leq D$; $A < V$; $R < D \geq S$

On combining, we get

$A < V < Q \leq D > R$; $S \leq D \geq Q > V$

Conclusions:

I. $S < V$: False (As $S \leq D \geq Q > V$, relation between S and V can't be determined)

II. $A < D$: True (As $A < V < Q \leq D$, so $A < D$)

III. $R < Q$: False (As $Q \leq D > R$, relation between R and Q can't be determined)

Hence, option a.

Blood relations

(4-5) Directions: Answer the questions based on the information given below.

There are six members C, D, K, L, M and R in a family, which consists of three generations. There are two couples in the family.

R is the father of C, who is the father of M. C has no brother. K is the mother-in-law of D.

Neither D nor M is male. L is the sister of C.

4. How is L related to D?

A -

Aunt

Wipro Elite NTH Reasoning Questions & Answers - Paper 4



B -
Sister

C -
Daughter

D -
Sister-in-law

Solution

Clues:

R is the father of C, who is the father of M. C has no brother. L is the sister of C. K is the mother-in-law of D. Neither D nor M is male member.

Inference:

K is the wife of R.

D is the wife of C.

L is the paternal aunt of M.

The family tree:

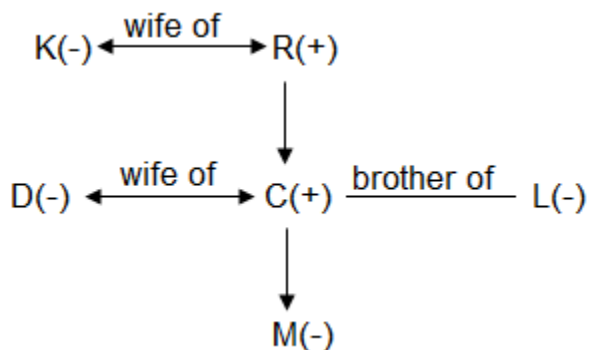

L is the sister-in-law of D.

Hence, option d.

Wipro Elite NTH Reasoning Questions & Answers - Paper 4



5. How is M related to D's husband?

A -

Daughter

B -

Sister

C -

Grand Daughter

D -

Niece

Solution

Clues:

R is the father of C, who is the father of M. C has no brother. L is the sister of C. K is the mother-in-law of D. Neither D nor M is male member.

Inference:

K is the wife of R.

D is the wife of C.

L is the paternal aunt of M.

The family tree:

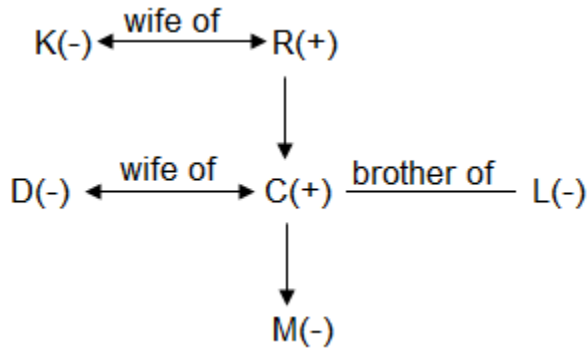

C is D's husband.

M is the daughter of C.

Hence, option a.

Logical inequalities

6. In the question, assuming the given statements to be true, find which of the conclusion (s) among given three conclusions is /are definitely true and then give your answer accordingly.

Statements: $T < M \leq Q$; $D < R$; $S \geq M$; $T < A < D$

Conclusions:

I. $R > T$

II. $S > A$

III. $D > M$

A -

Only conclusion II is true.

B -

Only conclusions I and II are true.

C -

Wipro Elite NTH Reasoning Questions & Answers - Paper 4



Only conclusions II and III are true.

D -

Only conclusion I is true.

Solution

Given statements: $T < M \leq Q$; $D < R$; $S \geq M$; $T < A < D$

On combining, we get

$S \geq M > T < A < D < R$; $Q \geq M > T < A < D$

Conclusions:

I. $R > T$: True (As $T < A < D < R$, so $R > T$)

II. $S > A$: False (As $S \geq M > T < A$, relation between S and A can't be determined)

III. $D > M$: False (As $M > T < A < D$, relation between D and M can't be determined)

Hence, option d.

Alphabet test

7. How many pairs of letters are there in the word "LANGUETS" which has as many letters between them in the word as in the alphabet?

A -

Four

B -

Three

C -

Five

D -

More than Five

Solution

Wipro Elite NTH Reasoning Questions & Answers - Paper 4



Given: LANGUETS

LN, LS, AE, NS, EG and ST are the six pairs which have as many letters between them in the word as in the alphabet.

Hence, option d.

Circular sitting arrangement

(8-12) Directions: Answer the questions based on the information given below.

Eight students A, B, C, D, E, O, P and Q sit around a circular table equidistant from each other such that students, whose name starts with a vowel, face towards the centre while others face outside. Five of them have different ranks 1, 2, 3, 4 and 5 in a class test.

B sits 2nd to the left of D. Student, whose rank is 5, sits adjacent to B. C sits opposite to the one, whose rank is 5. O sits adjacent to C. Student, whose rank is 3, sits 2nd to the right of O. A sits immediate left of Q. P sits 2nd to the right of E but doesn't have any rank. B's rank is one more than the person, who sits to the immediate left of P. Neither C nor D has rank 4.

8. Who sits immediate right of the person, whose rank is 1?

A -

C

B -

Q

C -

B

D -

D

Solution

Wipro Elite NTH Reasoning Questions & Answers - Paper 4



Clues:

O sits adjacent to C.

Student, whose rank is 3, sits 2nd to the right of O.

P sits 2nd to the right of E but doesn't have any rank.

A sits immediate left of Q, this is not possible in case I, so case I is rejected.

Inference:

O sits immediate right of C.

Q's rank is 3 and E's rank is 5.

A sits immediate right of D.

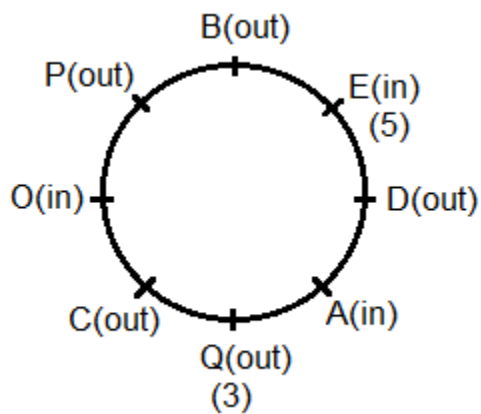

Clues:

B's rank is one more than the person, who sits immediate left of P.

Neither C nor D has rank 4.

Inference:

B's rank is 2 and O's rank is 1.

A's rank is 4.

The final seating arrangement is given below:

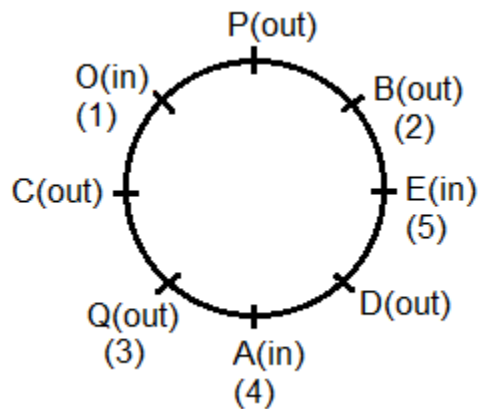

C sits immediate right of O, whose rank is 1.

Hence, option a.

9. What is the position of the B with respect to the student, whose rank is 4?

- A -
3rd to the left
- B -
2nd to the left
- C -
3rd to the right**
- D -
4th to the right

Solution

Starting Point: First we shall try to place B and D, and then proceed by placing the student, whose rank is 5, so as to get only two cases.

Clues:

Wipro Elite NTH Reasoning Questions & Answers - Paper 4



B sits 2nd to the left of D.

Student, whose rank is 5, sits adjacent to B.

C sits opposite to the one, whose rank is 5.

Inference:

Student, whose rank is 5, sits either immediate left of B or immediate right of B.

C sits immediate right of D or 3rd to the right of D.

Case I: Student, whose rank is 5, sits immediate left of B:

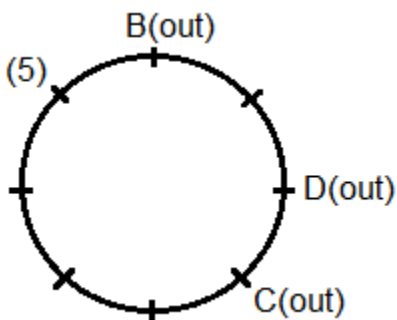

Case II: Student, whose rank is 5, sits immediate right of B:

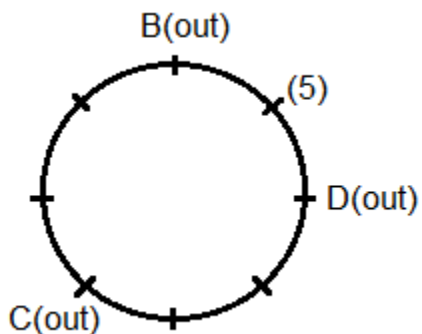

Clues:

O sits adjacent to C.

Wipro Elite NTH Reasoning Questions & Answers - Paper 4



Student, whose rank is 3, sits 2nd to the right of O.

P sits 2nd to the right of E but doesn't have any rank.

A sits immediate left of Q, this is not possible in case I, so case I is rejected.

Inference:

O sits immediate right of C.

Q's rank is 3 and E's rank is 5.

A sits immediate right of D.

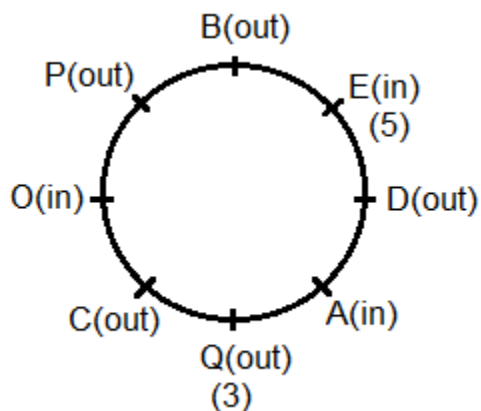

Clues:

B's rank is one more than the person, who sits immediate left of P.

Neither C nor D has rank 4.

Inference:

B's rank is 2 and O's rank is 1.

A's rank is 4.

The final seating arrangement is given below:

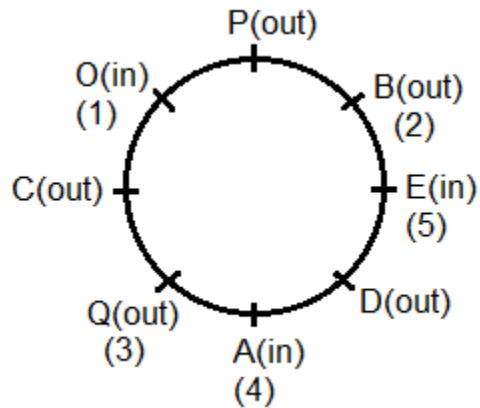

B sits 3rd to the right of A, whose rank is 4.

Hence, option c.

10. Who sits opposite to the student, whose rank is 2?

A -

O

B -

Q

C -

A

D -

E

Solution

Starting Point: First we shall try to place B and D, and then proceed by placing the student, whose rank is 5, so as to get only two cases.

Clues:

B sits 2nd to the left of D.

Wipro Elite NTH Reasoning Questions & Answers - Paper 4



Student, whose rank is 5, sits adjacent to B.

C sits opposite to the one, whose rank is 5.

Inference:

Student, whose rank is 5, sits either immediate left of B or immediate right of B.

C sits immediate right of D or 3rd to the right of D.

Case I: Student, whose rank is 5, sits immediate left of B:

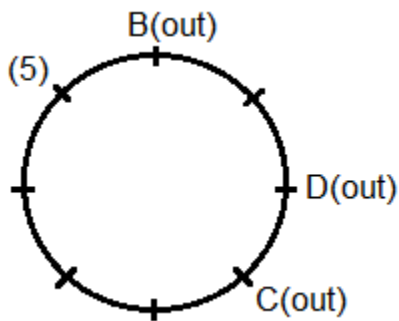

Case II: Student, whose rank is 5, sits immediate right of B:

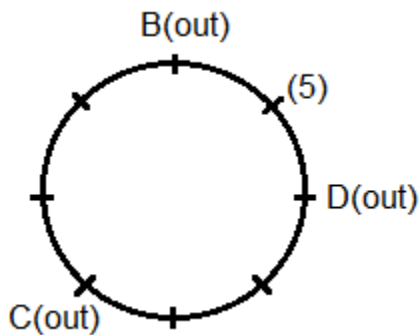

Clues:

O sits adjacent to C.

Student, whose rank is 3, sits 2nd to the right of O.

Wipro Elite NTH Reasoning Questions & Answers - Paper 4



P sits 2nd to the right of E but doesn't have any rank.

A sits immediate left of Q, this is not possible in case I, so case I is rejected.

Inference:

O sits immediate right of C.

Q's rank is 3 and E's rank is 5.

A sits immediate right of D.

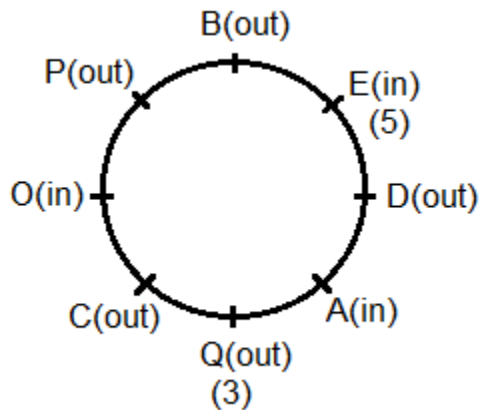

Clues:

B's rank is one more than the person, who sits immediate left of P.

Neither C nor D has rank 4.

Inference:

B's rank is 2 and O's rank is 1.

A's rank is 4.

The final seating arrangement is given below:

Wipro Elite NTH Reasoning Questions & Answers - Paper 4

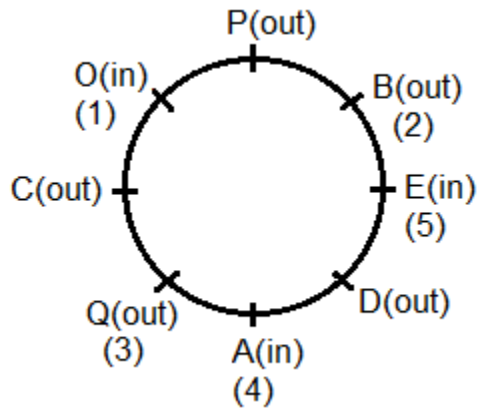

Q sits opposite to B, whose rank is 2.

Hence, option b.

11. Find the odd one out.

A -

D

B -

E

C -

B

D -

O

Solution

Starting Point: First we shall try to place B and D, and then proceed by placing the student, whose rank is 5, so as to get only two cases.

Clues:

B sits 2nd to the left of D.

Wipro Elite NTH Reasoning Questions & Answers - Paper 4



Student, whose rank is 5, sits adjacent to B.

C sits opposite to the one, whose rank is 5.

Inference:

Student, whose rank is 5, sits either immediate left of B or immediate right of B.

C sits immediate right of D or 3rd to the right of D.

Case I: Student, whose rank is 5, sits immediate left of B:

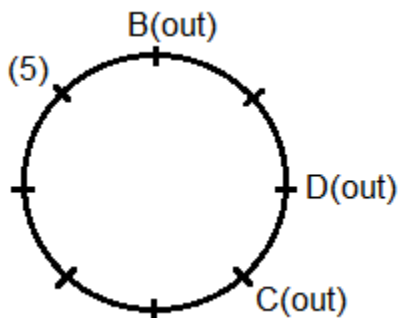

Case II: Student, whose rank is 5, sits immediate right of B:

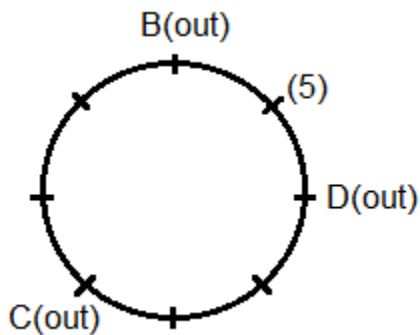

Clues:

O sits adjacent to C.

Student, whose rank is 3, sits 2nd to the right of O.

Wipro Elite NTH Reasoning Questions & Answers - Paper 4



P sits 2nd to the right of E but doesn't have any rank.

A sits immediate left of Q, this is not possible in case I, so case I is rejected.

Inference:

O sits immediate right of C.

Q's rank is 3 and E's rank is 5.

A sits immediate right of D.

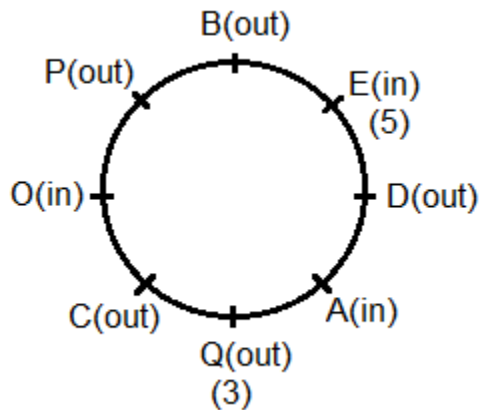

Clues:

B's rank is one more than the person, who sits immediate left of P.

Neither C nor D has rank 4.

Inference:

B's rank is 2 and O's rank is 1.

A's rank is 4.

The final seating arrangement is given below:

Wipro Elite NTH Reasoning Questions & Answers - Paper 4

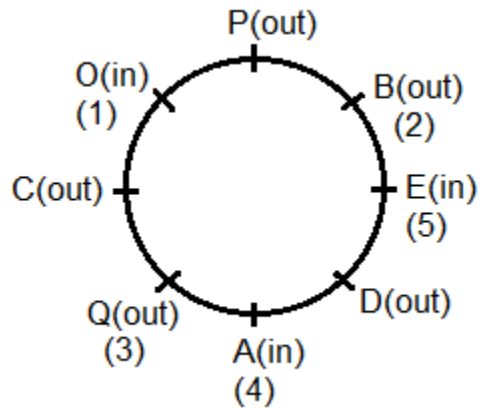

All except D are rank holders.

Hence, option a.

12. Who sits 3rd to the right of E?

A -

C

B -

Q

C -

O

D -

P

Solution

Starting Point: First we shall try to place B and D, and then proceed by placing the student, whose rank is 5, so as to get only two cases.

Clues:

B sits 2nd to the left of D.

Wipro Elite NTH Reasoning Questions & Answers - Paper 4



Student, whose rank is 5, sits adjacent to B.

C sits opposite to the one, whose rank is 5.

Inference:

Student, whose rank is 5, sits either immediate left of B or immediate right of B.

C sits immediate right of D or 3rd to the right of D.

Case I: Student, whose rank is 5, sits immediate left of B:

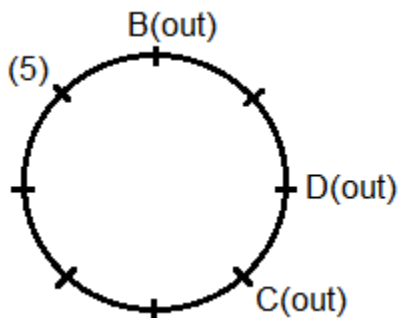

Case II: Student, whose rank is 5, sits immediate right of B:

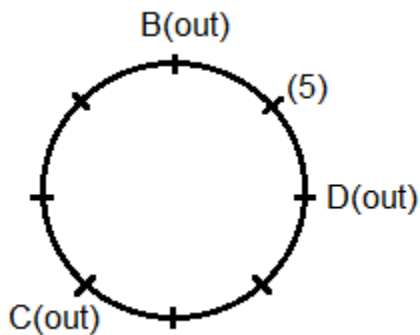

Clues:

O sits adjacent to C.

Student, whose rank is 3, sits 2nd to the right of O.

Wipro Elite NTH Reasoning Questions & Answers - Paper 4



P sits 2nd to the right of E but doesn't have any rank.

A sits immediate left of Q, this is not possible in case I, so case I is rejected.

Inference:

O sits immediate right of C.

Q's rank is 3 and E's rank is 5.

A sits immediate right of D.

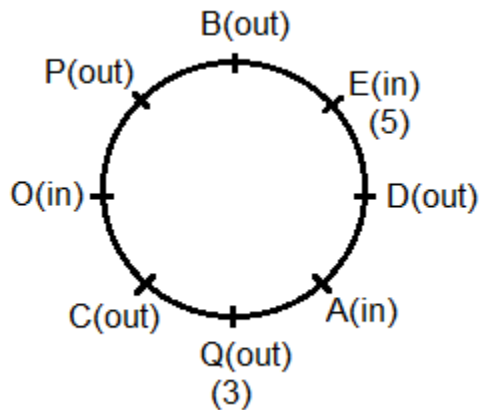

Clues:

B's rank is one more than the person, who sits immediate left of P.

Neither C nor D has rank 4.

Inference:

B's rank is 2 and O's rank is 1.

A's rank is 4.

The final seating arrangement is given below:

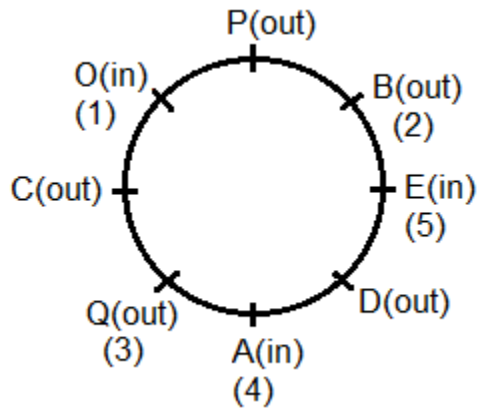

O sits 3rd to the right of E.

Hence, option c.

Ordering & ranking

(13-14) Directions: Answer the questions based on the information given below.

Six persons A, C, D, K, M and R have different number of coins. More than two persons have more coins than M. D has lowest number of coins. Less than four persons have fewer coins than A.

R doesn't have 3rd highest number of coins. C has more coins than K, who has more coins than R.

12. Who has 3rd highest number of coins?

A -

A

B -

K

C -

M

D -

Wipro Elite NTH Reasoning Questions & Answers - Paper 4



Can't be determined

Solution

Clues:

More than two persons have more coins than M. D has lowest number of coins.
Less than four persons have fewer coins than A. C has more coins than K, who has more coins than R. R doesn't have 3rd highest number of coins.

Inference:

C has highest number of coins.

K has 2nd highest number of coins.

$C > K > A > M/R > R/M > D$

A has 3rd highest number of coins.

Hence, option a.

13. How many persons have more coins than M?

A -

Two

B -

Four

C -

Three

D -

Can't be determined

Solution

Clues:

Wipro Elite NTH Reasoning Questions & Answers - Paper 4



More than two persons have more coins than M. D has lowest number of coins. Less than four persons have fewer coins than A. C has more coins than K, who has more coins than R. R doesn't have 3rd highest number of coins.

Inference:

C has highest number of coins.

K has 2nd highest number of coins.

$C > K > A > M/R > R/M > D$

Either three or four persons have more coins than M.

Hence, option d.

Logical inequalities

14. In the question, assuming the given statements to be true, find which of the conclusion (s) among given three conclusions is /are definitely true and then give your answer accordingly.

Statements: $T > A \geq R$; $S \leq T$; $L \leq V < A$

Conclusions:

I. $T > L$

II. $A < S$

III. $V < R$

A -

Only conclusion II is true.

B -

Only conclusion I is true.

C -

Only conclusions I and II are true.

Wipro Elite NTH Reasoning Questions & Answers - Paper 4



D -

Only conclusions II and III are true.

Solution

Given statements: $T > A \geq R$; $S \leq T$; $L \leq V < A$

On combining, we get

$S \leq T > A > V \geq L$; $R \leq A > V$; $R \leq A < T \geq S$

<https://www.freshersnow.com/placement-papers-download/>

Conclusions:

I. $T > L$: True (As $T > A > V \geq L$, so $T > L$)

II. $A < S$: False (As $A < T \geq S$, relation between A and S can't be determined)

III. $V < R$: False (As $R \leq A > V$, relation between V and R can't be determined)

Hence, option b.