DO NOT OPEN THIS TEST BOOKLET UNTIL YOU ARE TOLD TO DO SO

T.B.C. : PKL-D-ELX

Test Booklet Series

Serial No. **1016149**

TEST BOOKLET
PAPER—II

(Electronics and Telecommunication Engineering)

Time Allowed : Three Hours

Maximum Marks : 300

INSTRUCTIONS

1. IMMEDIATELY AFTER THE COMMENCEMENT OF THE EXAMINATION, YOU SHOULD CHECK THAT THIS TEST BOOKLET DOES NOT HAVE ANY UNPRINTED OR TORN OR MISSING PAGES OR ITEMS, ETC. IF SO, GET IT REPLACED BY A COMPLETE TEST BOOKLET.
2. Please note that it is the candidate's responsibility to encode and fill in the Roll Number and Test Booklet Series A, B, C or D carefully and without any omission or discrepancy at the appropriate places in the OMR Answer Sheet. Any omission/discrepancy will render the Answer Sheet liable for rejection.
3. You have to enter your Roll Number on the Test Booklet in the Box provided alongside. *DO NOT* write anything else on the Test Booklet.
4. This Test Booklet contains **150** items (questions). Each item comprises four responses (answers). You will select the response which you want to mark on the Answer Sheet. In case you feel that there is more than one correct response, mark the response which you consider the best. In any case, choose *ONLY ONE* response for each item.
5. You have to mark all your responses *ONLY* on the separate Answer Sheet provided. See directions in the Answer Sheet.
6. *All* items carry equal marks.
7. Before you proceed to mark in the Answer Sheet the response to various items in the Test Booklet, you have to fill in some particulars in the Answer Sheet as per instructions sent to you with your Admission Certificate.
8. After you have completed filling in all your responses on the Answer Sheet and the examination has concluded, you should hand over to the Invigilator *only the Answer Sheet*. You are permitted to take away with you the Test Booklet.
9. Sheets for rough work are appended in the Test Booklet at the end.
10. **Penalty for wrong answers :**
THERE WILL BE PENALTY FOR WRONG ANSWERS MARKED BY A CANDIDATE.
 - (i) There are four alternatives for the answer to every question. For each question for which a wrong answer has been given by the candidate, **one-third** of the marks assigned to that question will be deducted as penalty.
 - (ii) If a candidate gives more than one answer, it will be treated as a **wrong answer** even if one of the given answers happens to be correct and there will be same penalty as above to that question.
 - (iii) If a question is left blank, i.e., no answer is given by the candidate, there will be **no penalty** for that question.

DO NOT OPEN THIS TEST BOOKLET UNTIL YOU ARE TOLD TO DO SO

1. The atomic packing factor of a simple cubic structure is
 - (a) 0.42
 - (b) 0.62
 - (c) 0.52
 - (d) 0.72

2. For some solid materials, each atom possesses a permanent dipole moment by
 - (a) virtue of incomplete cancellation of electron spin and/or orbital magnetic moments
 - (b) rotation and alignment with external field
 - (c) the presence of external field
 - (d) rotation in opposite direction with external field

3. Which one of the following statements is **not** correct regarding laminates?
 - (a) Paper reinforced laminates can be used in thickness ranging between 0.2 mm and 50 mm.
 - (b) Paper reinforced laminates are used in applications involving power frequencies and voltages up to 1 kV.
 - (c) Glass reinforced laminates make use of phenol formaldehyde as impregnant and adhesive.
 - (d) Asbestos reinforced laminates have higher electrical characteristics than paper reinforced laminates.

4. Which one of the following statements is **not** correct regarding mercury?
 - (a) Mercury is a heavy silver white metal.
 - (b) The specific weight of mercury is approximately 31.55 gm/cm^3 .
 - (c) Mercury is the only metal which is liquid at room temperature.
 - (d) The boiling point of mercury is approximately 357°C .

5. What is the value of interplanar spacing for (2 3 1) plane of an FCC structure whose atomic radius is 0.125 nm?
 - (a) $d_{231} = 0.443 \text{ nm}$
 - (b) $d_{231} = 0.343 \text{ nm}$
 - (c) $d_{231} = 0.094 \text{ nm}$
 - (d) $d_{231} = 0.194 \text{ nm}$

6. When a bar is subjected to a rapidly alternating magnetic field, there is rapid extension and contraction in the length of the bar. This phenomenon is known as
 - (a) hysteresis
 - (b) saturation magnetization
 - (c) magnetostriction
 - (d) diamagnetism

7. The material composed of C_{60} molecule that contains sixty carbon atoms in a network of sp^2 bonding which forms a spherical structure, is known as

- (a) buckminsterfullerene
- (b) haeckelite
- (c) carbon nanocone
- (d) carbon nanotube

8. The electronic properties of the nanotubes could be changed between metallic and semiconducting simply by varying

- (a) the tube length
- (b) the tube diameter
- (c) the tube perimeter
- (d) the tube width

9. A very low temperature, where resistivity of certain materials abruptly plunges from a finite value to one that is virtually zero and remains there upon further cooling, is called

- (a) knee temperature
- (b) ambient temperature
- (c) critical temperature
- (d) Curie temperature

10. Superconducting materials are used in which of the following applications?

- 1. Magnetic Resonance Imaging (MRI)
- 2. Magnetic Resonance Spectroscopy (MRS)
- 3. High-speed switching and signal transmission for computers
- 4. High-speed magnetically levitated trains

Select the correct answer using the code given below.

- (a) 1 and 2 only
- (b) 3 and 4 only
- (c) 2, 3 and 4 only
- (d) 1, 2, 3 and 4

11. Consider the following statements :

- 1. Some materials are capable of absorbing energy and then reemitting visible light in a phenomenon called luminescence.
- 2. If the delay time between absorption and reemission is much less than one second, the phenomenon is termed as phosphorescence.
- 3. If the delay time between absorption and reemission is much greater than one second, the phenomenon is termed as fluorescence.

Which of the above statements is/are **not** correct?

- (a) 1 only
- (b) 2 only
- (c) 1 and 2
- (d) 2 and 3

12. Which of the following are **not** the production methods for carbon nanotubes?

1. Electric arc discharge method
2. Laser vaporization method
3. Czochralski method
4. Metallization method

Select the correct answer using the code given below.

- (a) 1 and 2
- (b) 2 and 3 only
- (c) 3 and 4 only
- (d) 2, 3 and 4

13. Which one of the following statements is correct regarding induction motor?

- (a) If the stator voltage is changed, the torque will not change.
- (b) The motor has no starting torque.
- (c) At high slip (speed), the torque is inversely proportional to square of the slip.
- (d) At low slip (speed), the torque is directly proportional to the slip.

14. What is the coil pitch to eliminate the 5th harmonic in the induced e.m.f. of a synchronous generator?

- (a) 36°
- (b) 180°
- (c) 144°
- (d) 160°

15. Which one of the following represents a single element such as a voltage source or a resistor?

- (a) Branch
- (b) Node
- (c) Loop
- (d) Circuit

16. What is the value of the maximum power transferred to the load resistor R_L in the given circuit?

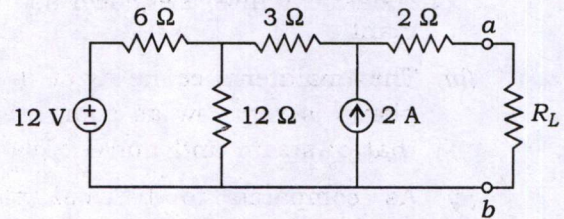

- (a) 11.43 W
- (b) 12.43 W
- (c) 13.44 W
- (d) 14.44 W

17. In the figure given below, the value of voltage drop across the resistor R_1 is

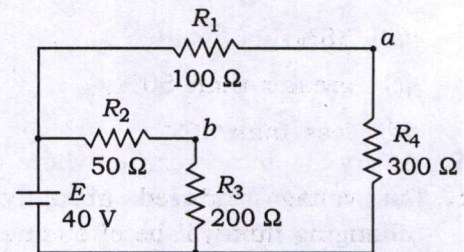

- (a) 100 V
- (b) 10 V
- (c) 1 V
- (d) 0.1 V

18. Which one of the following is a merit of nuclear power plant?

- (a) Large quantity of fuel storage facility is required in nuclear power plant
- (b) The maintenance cost of hydro plants is very low as compared to that of steam and nuclear plants
- (c) As compared to thermal plant, the space required for nuclear power plant is less
- (d) The initial cost of nuclear power plant is higher as compared to that of the other types of power plants

19. Which one of the following is **not** a part of the nuclear reactor?

- (a) Moderator
- (b) Biological shield
- (c) Economizer
- (d) Reflector

20. The efficiency of a nuclear plant is

- (a) 48%
- (b) 35%
- (c) greater than 50%
- (d) less than 30%

21. The voltage induced in a coil by a changing flux will be of such a polarity that if a current could flow as a result of that induced voltage, the flux established by that current would oppose the causing or original flux change. It is known as

- (a) Faraday's law
- (b) Lenz's law
- (c) Biot-Savart law
- (d) Ampere's circuital law

22. The measure of a coil's ability to produce flux is called

- (a) electromotive force
- (b) magnetic lines of force
- (c) magnetomotive force
- (d) magnetism

23. Which one of the following temperatures exists for the magnetic moments of a ferromagnetic material which become sufficiently diverse in orientation that the material becomes nonmagnetic?

- (a) Room temperature
- (b) Absolute temperature
- (c) Curie temperature
- (d) Ambient temperature

24. Which one of the following statements is correct regarding Leclanché cell?

- (a) The resulting cell voltage for Leclanché cell is 3.5 V.
- (b) Zinc powder acts as cathode in Leclanché cell.
- (c) Manganese dioxide acts as anode in Leclanché cell.
- (d) A coal/manganese dioxide cathode, a zinc anode and ammonium chloride solution as electrolyte are used in Leclanché cell.

25. Which one of the following statements is **not** correct regarding carrier lifetime in semiconductors?

- (a) Carrier lifetime ranges from nanoseconds to hundreds of microseconds.
- (b) On an average, a hole (an electron) will exist for τ_p sec before recombination.
- (c) τ_n is the time, it takes the total concentration to fall to approximately 63% of its initial value.
- (d) τ_p is the time, it takes the injected concentration to fall to approximately 37% of its initial value.

26. At what condition does the Fermi energy level (E_F) lie exactly between the band gap for intrinsic semiconductor?

- (a) The effective masses of a hole and a free electron are the same
- (b) The effective mass of a free electron is less than the effective mass of a hole
- (c) The effective mass of a free electron is greater than the effective mass of a hole
- (d) The effective mass of a hole is always in the centre of the forbidden energy band

27. In resistance levels, the AC or the dynamic resistance of a $p-n$ junction diode is defined by

- (a) a point on the characteristics
- (b) a tangent line at the Q-point in graphical determination
- (c) the straight line between limits of operation
- (d) the ratio of current through load to voltage across load

28. Consider the following statements regarding comparison of FET with BJT :

1. BJT is less noisy than FET.
2. FET is current-controlled device, whereas BJT is voltage-controlled device.
3. FETs are more temperature stable compared to BJTs.
4. FETs are simple to fabricate and occupy less area on the single chip.

Which of the above statements are correct?

- (a) 1 and 2
- (b) 1 and 3
- (c) 3 and 4
- (d) 1 and 4

29. Which one of the following is correct regarding stability factor with standard notations?

$$(a) S(I_{CO}) = \frac{\Delta I_C}{\Delta I_{CO}}$$

$$(b) S(I_{CO}) = \frac{\Delta I_{CO}}{\Delta I_C}$$

$$(c) S(V_{BE}) = \frac{\Delta I_C}{\Delta I_{CO}}$$

$$(d) S(V_{BE}) = \frac{\Delta I_C}{\Delta \beta}$$

30. Which one of the following is a transfer characteristic of NMOS with standard notations?

$$(a) I_D = I_{DSS} \left(1 - \frac{V_{GS}}{V_P} \right)^2$$

$$(b) I_D = I_{DSS} \left(1 - \frac{V_P}{V_{GS}} \right)^2$$

$$(c) I_D = k(V_{GS} - V_T)^2$$

$$(d) I_D = k(V_T + V_{GS})^2$$

31. Which one of the following statements is correct for n -channel or p -channel MOSFET?

(a) Drain resistance of MOSFET is very larger than JFET.

(b) Transconductance and inter-electrode capacitances have comparable values for the two types of devices.

(c) Input resistance and feedback resistance are very smaller than JFET.

(d) Input resistance and feedback resistance are comparable to JFET.

32. Which one of the following statements is **not** correct for typical h -parameter values for a transistor?

(a) Input impedance is high in case of common emitter and common collector as compared to common base configuration.

(b) Output conductance is low in case of common emitter and common collector as compared to common base configuration.

(c) Reverse voltage gain is high in common collector as compared to common base and common emitter configuration.

(d) Current gain is positive for common emitter and negative for common collector and common base configuration.

33. Which one of the following technologies consumes less power?
- Surface-mount technology
 - CMOS
 - NMOS
 - PMOS
34. Which one of the following requires additional process steps in their fabrication?
- Thin film resistor
 - Epitaxial resistor
 - Pinched resistor
 - Junction resistor
35. In monolithic integrated circuits, the concentration of acceptor atoms in the region between isolation islands will be
- much higher than in the p -type substrate
 - much lesser than in the p -type substrate
 - equal to the p -type substrate
 - not equal to the p -type substrate
36. A circuit that amplifies the difference between two signals is called
- differential amplifier
 - operational amplifier
 - buffer
 - level translator
37. The output of an LVDT is connected to a 5 V voltmeter through an amplifier whose amplification factor is 200. An output of 2 mV appears across the terminals of the LVDT when the core moves through a distance of 0.5 mm. The milli-voltmeter scale has 100 divisions and scale can read to $1/5$ of a division. The sensitivity and the resolution of the instrument are respectively
- 400 mV/mm and 2.25×10^{-3} mm
 - 800 mV/mm and 2.25×10^{-3} mm
 - 800 mV/mm and 1.25×10^{-3} mm
 - 400 mV/mm and 1.25×10^{-3} mm
38. The coil of a recording ammeter is 65 mm long and 25 mm wide. The rated current of the coil is 10 mA. The flux density in the air gap is 0.0046 Wb/m^2 . The damping constant is $0.008 \text{ N-m/rad-s}^{-1}$. The moment of inertia is 0.008 kg-m^2 . The spring constant is 0.016 N-m/rad . The Coulomb friction is $0.2 \times 10^{-6} \text{ N-m}$. The number of turns on the coil to produce a deflection of 100° at rated current is approximately
- 374582
 - 471548
 - 581548
 - 675284

39. Consider the following statements regarding data acquisition systems :

1. Digital data acquisition systems are used when wide frequency width is required.
2. Analog data acquisition systems are more complex than digital systems.
3. Digital data acquisition systems are used when the physical quantity being monitored has a narrow bandwidth.

Which of the above statements are **not** correct?

- (a) 1 and 2 only
- (b) 1 and 3 only
- (c) 1, 2 and 3
- (d) 2 and 3 only

40. Wave analyzer is also known as

- (a) selective level meter
- (b) precision receiver
- (c) modulation analyzer
- (d) audio analyzer

41. What is the displayed rise time (approximately) when a pulse waveform with a rise time of 21 ns is applied to an oscilloscope that has an upper cutoff frequency of 50 MHz?

- (a) 18 ns
- (b) 22 ns
- (c) 32 ns
- (d) 28 ns

42. An FM telemetry system uses a 370 Hz-430 Hz voltage-controlled oscillator to carry the fuel level of 3000 l tank, where 370 Hz represents an empty tank and 430 Hz represents full tank. What level does 408 Hz represent?

- (a) 1650.66 l
- (b) 2533.33 l
- (c) 3301.32 l
- (d) 4504.18 l

43. Four strain gauges are mounted on a simple flat tensile specimen arranged for complete temperature compensation and maximum sensitivity when connected in a four-arm bridge circuit. An $8 \times 10^5 \Omega$ calibration resistor is shunted across one of the strain gauges. If the gauge resistances are each 188 Ω and the gauge factors are 1.22, then the effective strain is

- (a) 545×10^{-6}
- (b) 775×10^{-6}
- (c) 48.1×10^{-6}
- (d) 32.4×10^{-6}

44. A 0-200 V voltmeter has a guaranteed accuracy of 1 percent of full-scale reading. The voltage measured by this instrument is 150 V. The percentage limiting error is

- (a) 25.00%
- (b) 12.50%
- (c) 2.66%
- (d) 1.33%

45. A voltage has a true value of 1.55 V. An analog indicating instrument with a scale range of 0-2.5 V shows a voltage of 1.48 V. What is the relative error?

- (a) -2.67%
- (b) -1.60%
- (c) -4.52%
- (d) -2.80%

46. The measurement precision of an instrument defines the smallest change in measured quantity that can be observed, which is called

- (a) accuracy of the instrument
- (b) precision of the instrument
- (c) resolution of the instrument
- (d) significant figure of the instrument

47. Consider the following statements :

1. The caesium beam and the hydrogen maser are the primary or absolute standards.
2. The rubidium vapour standard is based on the hyperfine transition in rubidium-78 gas, between the states $F = 2$ and $F = 1$.
3. The secondary standard of e.m.f. is the unsaturated Weston cell.

Which of the above statements are correct?

- (a) 1 and 2 only
- (b) 1 and 3 only
- (c) 1, 2 and 3
- (d) 2 and 3 only

48. Which one of the following statements is correct regarding standards of measurements?

- (a) The primary standards are as accurate as the international standards.
- (b) The secondary standards are preserved at the 'International Bureau of Weights and Measures' and not available to the ordinary users.
- (c) The secondary standards are the absolute standards and not as accurate as the international standards.
- (d) Working standards are used by manufacturers for comparing and standardizing their products.

49. A path is a particular subgraph consisting of an ordered sequence of branches having which of the following properties?

1. At all but two of its nodes, called internal nodes, there are incident exactly two branches of the subgraph.
2. At each of the remaining two nodes, called terminal nodes, there is incident exactly one branch of the subgraph.

Select the correct answer using the code given below.

- (a) 1 only
- (b) 2 only
- (c) Neither 1 nor 2
- (d) Both 1 and 2

50. What is the value of the source current (I_s) of the given network in the figure?

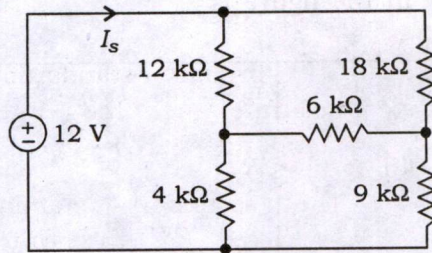

- (a) 1.2 A
 (b) 12 A
 (c) 1.2 mA
 (d) 12 mA

51. Which of the following properties of the circuits of a graph are correct?

1. The minimum number of branches possible in a circuit will be equal to the number of nodes or vertices.
2. There are exactly two paths between any pair of vertices in a circuit.
3. There are at least two branches in a circuit.

Select the correct answer using the code given below.

- (a) 1 and 2 only
 (b) 1 and 3 only
 (c) 2 and 3 only
 (d) 1, 2 and 3

52. What are the open-circuit reverse voltage gain and the short-circuit forward current gain respectively for the two-port network shown in the figure?

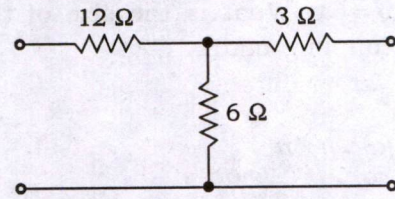

- (a) $\frac{1}{3}$ and $-\frac{1}{3}$
 (b) $-\frac{1}{3}$ and $\frac{1}{3}$
 (c) $\frac{2}{3}$ and $-\frac{2}{3}$
 (d) $-\frac{2}{3}$ and $\frac{2}{3}$

53. What are the open-circuit transfer admittance and the negative short-circuit current ratio respectively for the two-port network shown in the figure?

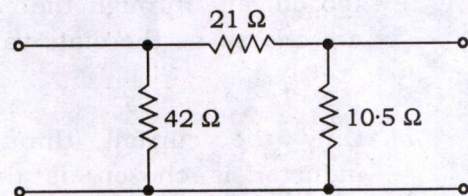

- (a) $\frac{2}{3}$ S and $\frac{3}{2}$
 (b) $\frac{1}{6}$ S and $\frac{3}{2}$
 (c) $\frac{1}{6}$ S and $\frac{2}{3}$
 (d) $\frac{2}{3}$ S and $\frac{2}{3}$

54. The dynamics of an n th order single-input single-output system can be written by the vector-matrix differential equation $\dot{x} = Ax + Bu$ and output $y = Cx$. What is the size of the output coupling matrix C ?

- (a) $n \times n$
- (b) $n \times 1$
- (c) $1 \times n$
- (d) 1×1

55. For the state variable formulation of R - L - C network, which one of the following statements is correct?

- (a) The voltage across the inductor and the current through the capacitor are chosen as the state variables.
- (b) Only the current through the inductor is chosen as the state variable.
- (c) Only the voltage across the capacitor is chosen as the state variable.
- (d) The current through the inductor and the voltage across the capacitor are chosen as the state variables.

56. If $i(t) = I_0 \sin \omega t$, then the state variable formulation of the R - L - C circuit shown in the figure is

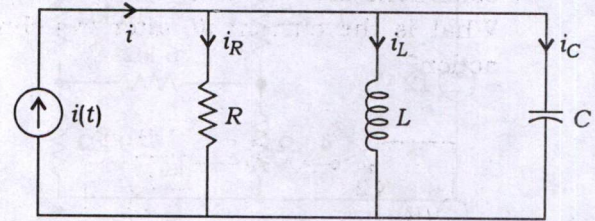

$$(a) \begin{bmatrix} \dot{x}_1 \\ \dot{x}_2 \end{bmatrix} = \begin{bmatrix} 0 & 1 \\ -1/LC & -1/RC \end{bmatrix} \begin{bmatrix} x_1 \\ x_2 \end{bmatrix} + \begin{bmatrix} 0 \\ I_0(\omega/C) \cos \omega t \end{bmatrix}$$

$$(b) \begin{bmatrix} \dot{x}_1 \\ \dot{x}_2 \end{bmatrix} = \begin{bmatrix} 0 & 1 \\ 1/LC & 1/RC \end{bmatrix} \begin{bmatrix} x_1 \\ x_2 \end{bmatrix} + \begin{bmatrix} 0 \\ I_0(\omega/C) \sin \omega t \end{bmatrix}$$

$$(c) \begin{bmatrix} \dot{x}_1 \\ \dot{x}_2 \end{bmatrix} = \begin{bmatrix} 0 & 1 \\ 1/LC & 1/RC \end{bmatrix} \begin{bmatrix} x_1 \\ x_2 \end{bmatrix} + \begin{bmatrix} 0 \\ I_0(\omega/C) \cos \omega t \end{bmatrix}$$

$$(d) \begin{bmatrix} \dot{x}_1 \\ \dot{x}_2 \end{bmatrix} = \begin{bmatrix} 0 & 1 \\ -1/LC & -1/RC \end{bmatrix} \begin{bmatrix} x_1 \\ x_2 \end{bmatrix} + \begin{bmatrix} 0 \\ I_0(\omega/C) \sin \omega t \end{bmatrix}$$

57. In the figure, the switch is thrown from position 1 to 2 at time $t = 0$. Just before the switch is thrown, the initial conditions are $i_L(0^-) = 2$ A, $v_C(0^-) = 2$ V. What is the current $i(t)$ after switching action?

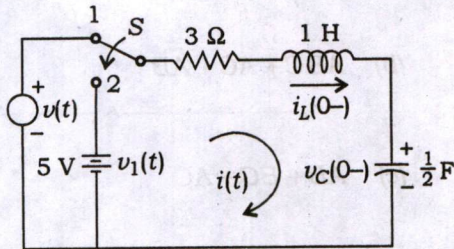

- (a) $e^{-t} + e^{-3t}$
 (b) $e^{-t} + e^{-2t}$
 (c) $e^t + e^{3t}$
 (d) $e^t + e^{2t}$

58. What is the output voltage $v_o(t)$ of the circuit shown in the figure?

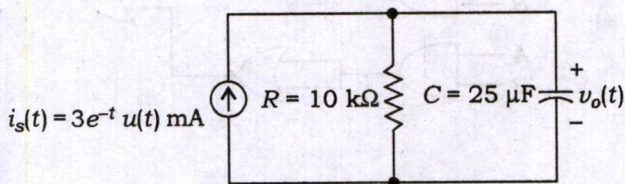

- (a) $v_o(t) = 20[e^{-t} - e^{-2t}]u(t)$ V
 (b) $v_o(t) = 40[e^{-t} - e^{-2t}]u(t)$ V
 (c) $v_o(t) = 40[e^{-t} - e^{-4t}]u(t)$ V
 (d) $v_o(t) = 20[e^{-t} - e^{-4t}]u(t)$ V

59. If the value of $E = 100$ V, $R = 10$ kΩ and $C = 10$ mF in the circuit shown in the figure, then the capacitor current (i_C) at $t = 150$ ms is

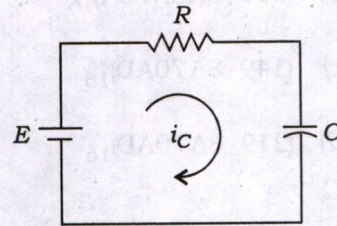

- (a) $100e^{-1.5}$ mA
 (b) $50e^{-1.5}$ mA
 (c) $10e^{-1.5}$ mA
 (d) $20e^{-1.5}$ mA

60. The capacitor of the figure shown below has 25 V on it with polarity shown at the time the switch is closed. The expression for v_C is

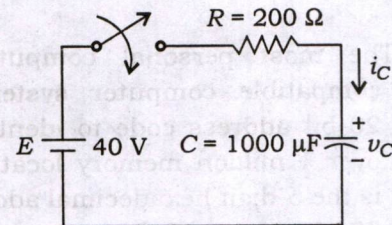

- (a) $(40 - 15e^{-5t})$ volts
 (b) $(40 - 20e^{-5t})$ volts
 (c) $(40 - 25e^{-3t})$ volts
 (d) $(40 - 40e^{-3t})$ volts

61. Convert $(329.54)_{10}$ to hexadecimal.

(a) $(149.8A3D70A)_{16}$

(b) $(219.8A3D70A)_{16}$

(c) $(149.8A70AD)_{16}$

(d) $(219.8A70AD)_{16}$

62. Represent the decimal number 396 in binary, Gray and excess-3 codes respectively.

(a) 110001100, 101011010,
110001111

(b) 110001010, 101101011,
110010000

(c) 101001010, 110001100,
110011111

(d) 110001100, 101001010,
110001111

63. The most personal computers (PCs)-compatible computer systems use a 20-bit address code to identify each of over 1 million memory locations. What is the 5-digit hexadecimal address of the 500th memory location?

(a) 001F3

(b) 001F4

(c) 001F5

(d) 001F6

64. Simplify the following Boolean function :

$$f(A, B, C) = \bar{A}BC + A\bar{B}C + AB\bar{C} + ABC$$

(a) $\bar{A}BC + A\bar{B}C + AB$

(b) $A\bar{B}C + AC + AB$

(c) $AB + BC + AC$

(d) $\bar{A}BC + AC + AB$

65. What is the output Y for the logic circuit shown in the figure?

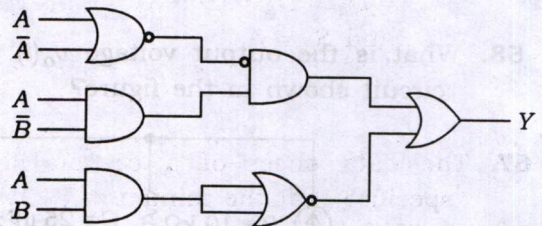

(a) $A\bar{B} + \bar{A}B$

(b) $A\bar{B} + \bar{A} + \bar{B}$

(c) $A\bar{B} + \bar{A}B$

(d) $\bar{A} + \bar{B}$

66. A , B and C_{in} are the three inputs of a full adder circuit and D_0, D_1, \dots, D_7 are the inputs of 8:1 multiplexer. S_2 (MSB), S_1 and S_0 (LSB) are the selection lines of the multiplexer. To implement the expression of sum of full adder circuit using this multiplexer, the connections of the input ports and selection lines are

(a) $D_0 = D_3 = D_5 = D_6 = 0, D_1 = D_2 = D_4 = D_7 = 1, S_2 = A, S_1 = B$ and $S_0 = C_{in}$

(b) $D_0 = D_3 = D_5 = D_6 = 1, D_1 = D_2 = D_4 = D_7 = 0, S_2 = C_{in}, S_1 = B$ and $S_0 = A$

(c) $D_0 = D_2 = D_3 = D_6 = 0, D_1 = D_4 = D_5 = D_7 = 1, S_2 = A, S_1 = B$ and $S_0 = C_{in}$

(d) $D_0 = D_1 = D_5 = D_7 = 1, D_2 = D_3 = D_4 = D_6 = 0, S_2 = C_{in}, S_1 = B$ and $S_0 = A$

67. The data sheet of a certain flip-flop specifies that the minimum HIGH time $t_w(H)$ for the clock pulse is 16 nanoseconds and the minimum LOW time $t_w(L)$ is 29 nanoseconds. What is the maximum operating frequency for the given flip-flop?

(a) 62.50 MHz

(b) 31.25 MHz

(c) 22.22 MHz

(d) 11.11 MHz

68. The Schmitt trigger can be used as which of the following?

1. Square-wave generator
2. Comparator
3. Astable multivibrator

Select the correct answer using the code given below.

(a) 1 and 3 only

(b) 1 and 2 only

(c) 2 and 3 only

(d) 1, 2 and 3

69. What are the approximate values of t_1 , t_2 , frequency and duty cycle of a 555 timer used as an astable multivibrator respectively? (Take $C = 680 \text{ pF}$)

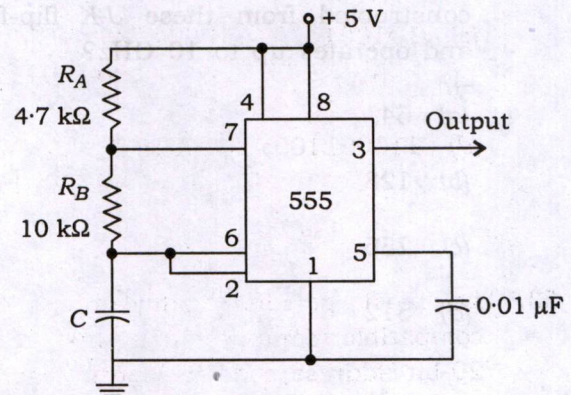

(a) 4.76 μsec , 6.997 μsec , 85 kHz and 59.5%

(b) 6.84 nsec, 9.997 nsec, 68 kHz and 59.5%

(c) 4.76 μsec , 6.997 μsec , 68 kHz and 68%

(d) 6.84 nsec, 9.997 nsec, 85 kHz and 68%

70. A five-bit asynchronous counter is shown in the figure. If the clock input frequency is 22.4 MHz, what is the frequency at the output E?

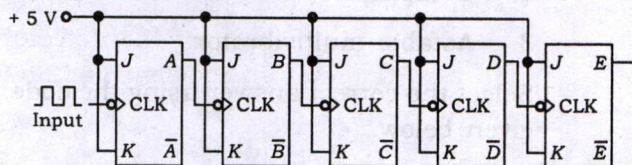

- (a) 700 kHz
- (b) 350 kHz
- (c) 150 MHz
- (d) 300 MHz

71. A certain J-K flip-flop has propagation delay 12 picoseconds. What is the largest MOD of a counter that can be constructed from these J-K flip-flops and operates up to 10 GHz?

- (a) 64
- (b) 128
- (c) 256
- (d) 512

72. Simplify the following Boolean expression using the De Morgan's theorem :

$$f(A, B, C, D, E, F) = \overline{(A+B)CD + (E+F)}$$

- (a) $(\bar{A} + \bar{B} + \bar{C})(\bar{D} + \bar{E} + \bar{F})$
- (b) $\overline{AB + CD + EF}$
- (c) $(\bar{A}\bar{B} + C + D)\bar{E}\bar{F}$
- (d) $\overline{ABC + DEF}$

73. The internet protocol (IP) (RFC 791) is the heart of the TCP/IP protocol suite. IP corresponds to the network layer in the OSI reference model and provides

- (a) a connectionless service to the application layer which requires a virtual circuit
- (b) high reliability in packet delivery
- (c) a connectionless best effort delivery service to the transport layer
- (d) reliability functions within a higher layer protocol

74. The orbital satellites are

- (a) symmetrical
- (b) asymmetrical
- (c) synchronous
- (d) nonsynchronous

75. The requirement for reliability, long life, stability, high efficiency and suitability for space environment are met by the use of

- (a) IF amplifier
- (b) RF amplifier
- (c) travelling wave tube amplifier
- (d) ultrasonic amplifier

76. The highest frequency that is returned to the earth at a given distance is called

- (a) maximum available frequency
- (b) maximum communication frequency
- (c) maximum bandwidth frequency
- (d) maximum usable frequency

77. The mean sun does move at a uniform speed but otherwise requires the same time as the real sun to complete one orbit of the earth, this time being

- (a) the tropical year
- (b) the leap year
- (c) the Julian calendar year
- (d) the Gregorian calendar year

78. Which one of the following statements is **not** correct regarding SONET networks?

- (a) A point-to-point network is normally made of an STS multiplexer.
- (b) A linear synchronous optical network can be point-to-point or multipoint.
- (c) The signal flow can be unidirectional or bidirectional.
- (d) A multipoint network uses STS multiplexers to allow the communications between several terminals.

79. A digital optical fiber communication system operating at a wavelength of $1\mu\text{m}$ requires a maximum bit error rate of 10^{-9} . What is the theoretical quantum limit at the receiver in terms of the quantum efficiency of the detector and the energy of an incident photon?

(a) $\frac{20 \cdot 7hf}{\eta}$

(b) $\frac{10 \cdot 7hf}{\eta}$

(c) $\frac{20 \cdot 7\eta}{hf}$

(d) $\frac{10 \cdot 7\eta}{hf}$

80. With frequency reuse, several cells with no space in a given coverage area use the same set of frequencies. Two cells using the same set of frequencies are called

(a) hexagonal shape cells

(b) adjacent channel cells

(c) cluster neighbour cells

(d) co-channel cells

81. The component in the satellite that takes an uplink signal and converts into a downlink signal is called

- (a) uplink device
- (b) transponder
- (c) downlink device
- (d) transmitter

82. An advantage of passive satellites is that they do not require sophisticated electronic equipment on board, although they are not necessary void of power. Some passive satellites require which one of the following for tracking and ranging purposes?

- (a) Radio beacon transmitter
- (b) Defense launched courier
- (c) Radio beacon receiver
- (d) Satellite beacon launcher

83. Some of the diffracted light continues down the fiber and some of it escapes through the cladding. The light rays that escape represent a loss in light power which is called

- (a) Rayleigh scattering loss
- (b) chromic distortion loss
- (c) chromatic distortion loss
- (d) predominant fiber loss

84. Numerical aperture is closely related to acceptance angle and is the figure of merit commonly used to measure

- (a) the sine of the maximum angle
- (b) the magnitude of the acceptance angle
- (c) the maximum angle of light ray
- (d) the intensity of light ray entering the cable

85. Consider the following statements regarding programmable interrupt controller 8259A :

1. 8259A is specifically designed for use with the interrupt signals (INTR/INT) of 8085 microprocessor.
2. It can solve eight levels of interrupt priorities in a variety of modes.
3. With additional 8259A devices, the priority scheme can be expanded to 32 levels.

Which of the above statements is/are **not** correct?

- (a) 1 and 3
- (b) 2 only
- (c) 3 only
- (d) 1 and 2

86. Consider the following statements regarding 8085 instruction set :

1. After execution of DAD instruction, if the result is larger than 16 bits, CY flag is set.
2. After execution of DCR instruction, S and CY flags will not be modified.
3. After execution of CMC instruction, only CY flag will be changed.

Which of the above statements is/are **not** correct?

- (a) 1 only
(b) 2 only
(c) 2 and 3
(d) 1 and 3

87. If the memory chip size is 1024×1 , then the number of memory chips needed to design 8 Kbyte memory is

- (a) 16
(b) 32
(c) 64
(d) 128

88. Which one of the following statements is correct for the given system?

$$y(n) = x^2(n) + \frac{1}{x^2(n-1)}$$

- (a) The given system is linear, non-causal and shift-variant.
(b) The given system is non-linear, causal and shift-invariant.
(c) The given system is non-linear, causal and shift-variant.
(d) The given system is linear, non-causal and shift-invariant.

89. If the impulse response $h(n)$ and the output $y(n)$ of a system are given as

$$h(n) = \{2, 1, 0, -1, 3\} \text{ and}$$

$$y(n) = \{2, -5, 1, 1, 6, -11, 6\}$$

then the input $x(n)$ of the system is

- (a) $\{1, -3, 2\}$
(b) $\{2, -3, 1\}$
(c) $\{1, 3, 2, 1\}$
(d) $\{2, -3, 1, 1\}$

90. The approximate transition width of main lobe in Blackman window is

- (a) $4\pi/N$
(b) $8\pi/N$
(c) $12\pi/N$
(d) $16\pi/N$

91. Consider the following statements regarding filters :

1. Cauer filter has equiripple passband and stopband.
2. For a given filter order, passband and stopband deviations, Cauer filters have more transition bandwidth as compared to Chebyshev filters.
3. Linear phase characteristics cannot be achieved in IIR filters.

Which of the above statements are correct?

- (a) 1 and 2 only
- (b) 1 and 3 only
- (c) 2 and 3 only
- (d) 1, 2 and 3

92. Consider the following statements regarding 8051 microcontroller :

1. The size of RAM in 8051 is 128 bytes.
2. RAM locations 00-1FH are assigned to the register banks and stack.
3. RAM locations 20-2FH are available as a place to save byte-sized data.

Which of the above statements are correct?

- (a) 1 and 2 only
- (b) 1 and 3 only
- (c) 2 and 3 only
- (d) 1, 2 and 3

93. Consider the following statements regarding nonvolatile RAM (NV-RAM) in 8051 :

1. When the power is turned off, the contents are lost.
2. NV-RAM uses extremely power-efficient SRAM cells built out of CMOS.
3. It uses an intelligent control circuitry.

Which of the above statements are correct?

- (a) 1, 2 and 3
- (b) 1 and 2 only
- (c) 2 and 3 only
- (d) 1 and 3 only

94. Which one of the following statements is **not** correct for CMOS technology in comparison with bipolar technology?

- (a) CMOS technology has low static power dissipation.
- (b) CMOS technology has high input impedance.
- (c) CMOS technology has high delay sensitivity to the load.
- (d) CMOS technology has high output drive current.

95. Consider the following statements regarding MOS circuit design process :

1. MOS circuits are formed on four basic layers : n -diffusion, p -diffusion, polysilicon and metal, which are isolated from one another by thick or thin silicon dioxide insulating layers.
2. Thin oxide (thinox) mask region includes n -diffusion, p -diffusion and transistor channels.
3. Polysilicon and thinox regions interact so that a transistor is formed where they cross one another.

Which of the above statements are correct?

- (a) 1 and 2 only
- (b) 1 and 3 only
- (c) 2 and 3 only
- (d) 1, 2 and 3

96. The ratio of total number of transistors on the chip to the number of transistor circuits that must be designed in detail is known as

- (a) capacity
- (b) regularity
- (c) design efficiency
- (d) design density

97. If V is a scalar, then the given equation (in spherical coordinate system)

$$\frac{1}{r^2} \frac{\partial}{\partial r} \left(r^2 \frac{\partial V}{\partial r} \right) + \frac{1}{r^2 \sin \theta} \frac{\partial}{\partial \theta} \left(\sin \theta \frac{\partial V}{\partial \theta} \right) + \frac{1}{r^2 \sin^2 \theta} \frac{\partial^2 V}{\partial \phi^2} = -\frac{\rho}{\epsilon}$$

is referred to as

- (a) Laplace's equation
- (b) Poisson's equation
- (c) gradient of V
- (d) divergence of V

98. The intrinsic impedance of free space is

- (a) 107 Ω
- (b) 214 Ω
- (c) 377 Ω
- (d) 754 Ω

99. Which one of the following is an angle at which there is no reflected wave when the incident wave is parallel (or vertically) polarized?

- (a) Critical angle
- (b) Reference angle
- (c) Relative angle
- (d) Brewster angle

100. The condition for the low-loss transmission line is

(a) $R \gg \omega C$ and $G \gg \omega L$

(b) $R \ll \omega L$ and $G \ll \omega C$

(c) $\frac{R}{G} = \frac{L}{C}$

(d) $RG \gg LC$

101. Consider the following statements regarding impedance matching :

1. When the line is terminated in an impedance other than its characteristic impedance, reflection will occur and there will be standing waves of voltage and current along the line which may be very large if there is considerable mismatch.
2. The single-stub device has the advantage that it will match any load.
3. The double stub has the disadvantage that the line length needs to be adjustable.

Which of the above statements are correct?

(a) 2 and 3 only

(b) 1 and 2 only

(c) 1 and 3 only

(d) 1, 2 and 3

102. The wave impedance in z direction for TE wave is

(a) $Z_z(\text{TE}) = \frac{\eta}{\sqrt{\left(1 + \frac{\omega_c^2}{\omega^2}\right)}}$

(b) $Z_z(\text{TE}) = \frac{2\eta}{\sqrt{\left(1 - \frac{\omega_c^2}{2\omega^2}\right)}}$

(c) $Z_z(\text{TE}) = \frac{\eta}{\sqrt{\left(1 - \frac{\omega_c^2}{\omega^2}\right)}}$

(d) $Z_z(\text{TE}) = \frac{2\eta}{\sqrt{\left(1 + \frac{\omega_c^2}{2\omega^2}\right)}}$

103. Which one of the following is the ratio of power lost per unit length to the twice of power transmitted?

(a) Attenuation factor

(b) Power efficiency

(c) Quality factor

(d) Transmission efficiency

104. A section of X-band waveguide with dimensions $a = 2.286$ cm and $b = 1.016$ cm has perfectly conducting walls and is filled with a lossy dielectric ($\sigma_d = 367.5 \frac{\mu\text{S}}{\text{m}}$, $\epsilon_r = 2.1$, $\mu_r = 1$). The cutoff frequency of TE_{10} for the dominant mode of propagation at a frequency of 9 GHz is

(a) 2.27 GHz

(b) 4.53 GHz

(c) 6.80 GHz

(d) 9.07 GHz

105. The antenna or array designed to yield directive gain appreciably greater than that obtainable from uniform distribution has become known as

(a) superheterodyne array

(b) supergain array

(c) super antenna

(d) universal antenna

106. In antennas, if S_A is the input signal generated by the source (by the receiving antenna) at temperature T_A , T_E is the effective noise temperature of the receiver network (referred to the input terminal), B is bandwidth and k is Boltzmann's constant, then the output signal-to-noise ratio is

(a) $\frac{S}{N} = \frac{S_A}{(T_A + T_E)kB}$

(b) $\frac{S}{N} = \frac{S_A T_A}{kBT_E}$

(c) $\frac{S}{N} = \frac{S_A(1 + T_A)}{kB(1 + T_E)}$

(d) $\frac{S}{N} = \frac{S_A T_A}{kB(1 + T_E)}$

107. The average value of the electrostatic field over the volume V of a sphere due to a point charge q somewhere within the sphere, where r_0 is the position of the charge, is

(a) $E_{\text{av}} = -\frac{qr_0}{3\epsilon_0 V}$

(b) $E_{\text{av}} = -\frac{qr_0}{4\pi\epsilon_0 V}$

(c) $E_{\text{av}} = \frac{qr_0}{3\epsilon_0 V}$

(d) $E_{\text{av}} = \frac{qr_0}{4\pi\epsilon_0 V}$

108. In the relation between the field and the potential, if $r < a$, then the potential at a point r inside a uniformly charged sphere of radius a , is

(a) $\frac{a^3 \rho}{3\epsilon_0 r}$

(b) $\frac{\rho}{6\epsilon_0} (3a^2 - r^2)$

(c) $\frac{4\pi a^3}{3r}$

(d) $\frac{2\pi}{3} (3a^2 - r^2)$

109. Which one of the following techniques is used to speed up the multiplication of two signed binary numbers in 2's complement notation?

- (a) K-Map algorithm
- (b) Booth's algorithm
- (c) Pascal's algorithm
- (d) De Morgan's algorithm

110. Which one of the following functions is **not** correct for an operating system?

- (a) Allocating storage and memory
- (b) Handling basic input and output operations
- (c) Providing protected sharing of the computer among multiple applications
- (d) Quick execution of instructions

111. Which of the following basic steps are needed in order to perform a memory read operation?

1. The address of the location from which the word is to be read is loaded into the memory address register (MAR).
2. A signal, called read (issued by the CPU indicating that the word whose address is in the MAR) is to be read into the MDR.
3. Corresponding to the memory delay in reading the specified word, the required word will be loaded by the memory into the MDR ready for use by the CPU.

Select the correct answer using the code given below.

- (a) 1 and 2 only
- (b) 2 and 3 only
- (c) 1 and 3 only
- (d) 1, 2 and 3

112. Which one of the following addressing modes is used to compute the address of the operand by adding a constant value to the content of a register?

- (a) Immediate addressing
- (b) Indexed addressing
- (c) Absolute addressing
- (d) Direct addressing

113. Which of the following statements is/are correct for memory-mapped I/O?

1. The advantage of memory-mapped I/O is the ability to execute a number of memory-dedicated instructions on the registers in the I/O devices in addition to the elimination of the need for dedicated I/O instructions.
2. The disadvantage of memory-mapped I/O is the need to dedicate part of the memory address space for I/O devices.

Select the correct answer using the code given below.

- (a) 1 only
- (b) 2 only
- (c) Neither 1 nor 2
- (d) Both 1 and 2

114. Which one of the following addressing modes is similar to the register indirect addressing mode in the sense that the effective address of the operand is the content of a register, which is included in the instruction?

- (a) Relative mode
- (b) Autoincrement mode
- (c) Autodecrement mode
- (d) Immediate addressing mode

115. A floating-point (FP) number is said to be normalized, if the leftmost bit of the mantissa is

- (a) 1
- (b) 0
- (c) -1
- (d) 2

116. In order to keep track of the instruction locations, which one of the following contains the value of memory location assigned to the instruction or operand being processed?

- (a) LD
- (b) STA
- (c) END
- (d) ILC

117. Addition of two n -bit numbers A and B can be carried out using n consecutive full adders in an arrangement, which is known as

- (a) carry-ripple counter
- (b) carry-ripple through adder
- (c) carry-ripple through binary
- (d) carry-ripple through subtractor

118. Which of the following instructions are long and allow maximum parallelism since each bit controls a single control line?

- (a) Horizontal microinstructions
- (b) Vertical microinstructions
- (c) Diagonal microinstructions
- (d) Jumbled microinstructions

119. Which one of the following tables is generated in pass one and has an entry for every symbol in the program to perform its function?

- (a) Symbol table
- (b) Opcode table
- (c) Pseudo-instruction table
- (d) Addressing instruction table

120. Which one of the following is the entity that can combine object modules that may have resulted from assembling multiple assembly modules separately?

- (a) Compiler
- (b) Interpreter
- (c) Linker
- (d) Loader

121. A unity feedback system has

$$G(s) = \frac{K(2s + 1)}{s(4s + 1)(s + 1)^2}$$

What is the value of K if the steady-state value of error is to be less than 0.1, when an input $r(t) = 1 + 5t$ is applied?

- (a) $K = 5$
- (b) $6 < K < 10$
- (c) $11 < K < 40$
- (d) $K > 50$

122. For the given control system, what is the value of K so that there is 10% error in the steady state?

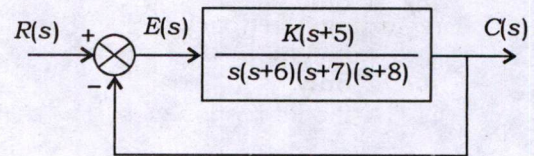

- (a) 172
- (b) 272
- (c) 572
- (d) 672

123. In an underdamped second-order system, the time required for the waveform to go from 0.1 of the final value to 0.9 of the final value is called

- (a) rise time
- (b) peak time
- (c) settling time
- (d) final time

124. The open-loop transfer function of a unity feedback system is given by

$$G(s) = \frac{K}{s(\tau s + 1)}$$

By what factor should the amplifier gain K be multiplied so that the damping ratio is increased from 0.25 to 0.75?

- (a) 0.1111
 (b) 1.1111
 (c) 0.3333
 (d) 3.3333

125. Consider the following statements regarding feedback compensation of control system :

1. A faster response can be achieved by the use of parallel compensation.
2. The environmental conditions in which the feedback control system is to be utilized affect the stability of the controlled quantity.
3. The degree of accuracy and the stability of a control system can be improved by the use of a cascade compensator.

Which of the above statements are correct?

- (a) 1 and 2 only
 (b) 1 and 3 only
 (c) 2 and 3 only
 (d) 1, 2 and 3

126. Consider the speed control system shown in the figure wherein the inner loop corresponds to motor back e.m.f., the controller is an integrator with gain K observes that the load is inertia only. What is the value of K for which steady-state error to unit ramp input $\left(V_r(s) = \frac{1}{s^2} \right)$ is less than 0.01 rad/sec?

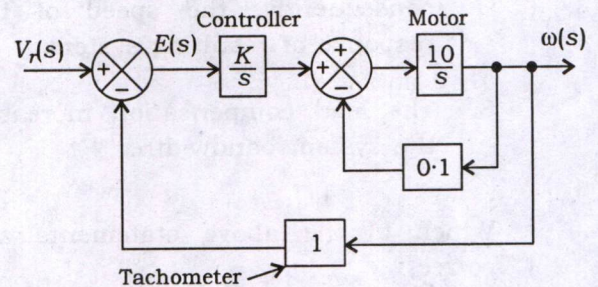

- (a) 5
 (b) 7
 (c) 10
 (d) 14
127. The subsystem that generates the input to the plant or process is known as

- (a) controller
 (b) controlled variable
 (c) controllability
 (d) compensator

128. Consider the following statements regarding compensator :

1. The lead compensator reduces the noise signal level relative to the control signal.
2. Introduction of cascade lead compensator increases the gain crossover frequency and, consequently, the speed of the response of resulting system.
3. The lead compensation increases the system bandwidth.

Which of the above statements are correct?

- (a) 1 and 2 only
- (b) 1 and 3 only
- (c) 2 and 3 only
- (d) 1, 2 and 3

129. Which of the following is/are used, when the cascade compensator does not employ pure integration?

- (a) Lead compensator only
- (b) Lag compensator only
- (c) Neither lead nor lag compensator
- (d) Both lead and lag compensators

130. Consider the following statements regarding signals :

1. Deterministic signal is a signal about which there is no uncertainty with respect to its value at any time.
2. Each signal within the ensemble has a certain probability of occurrence and the ensemble of signals is referred to as a random process.
3. EEG signal is an example of random signal.

Which of the above statements are correct?

- (a) 1 and 2 only
- (b) 1 and 3 only
- (c) 2 and 3 only
- (d) 1, 2 and 3

131. Which one of the following techniques can be used to analyze and design the effect of loop gain upon the system's transient response and stability?

- (a) Open-loop transfer function technique
- (b) Closed-loop transfer function technique
- (c) Root locus technique
- (d) Compensation technique

132. Consider the following statements regarding time response specifications :

1. Delay time is the time required for the response to reach 10% to 90% or 5% to 95% or 0% to 100% of its final value.
2. Peak time is the time required for the response to reach the first peak overshoot.
3. Settling time is the time required for the response to reach and maintain beyond a specified tolerance band, i.e., either 3% or 5% of the initial value.

Which of the above statements are **not** correct?

- (a) 1 and 2 only
- (b) 1 and 3 only
- (c) 2 and 3 only
- (d) 1, 2 and 3

133. Which one of the following fibers has the distinct advantage of low intermodal dispersion?

- (a) Multimode step-index fiber
- (b) Single-mode step-index fiber
- (c) Graded-index multimode fiber
- (d) Spatially incoherent multimode fiber

134. Which one of the following statements is **not** correct?

- (a) The noise performance of a full AM receiver is always inferior to that of a DSB-SC receiver.
- (b) The figure of merit of a DSB-SC receiver using coherent detection is always unity.
- (c) The figure of merit of an SSB receiver using coherent detection is always unity.
- (d) The figure of merit of an AM receiver using envelope detection is always greater than unity.

135. The RF carrier range and IF bandwidth corresponding to AM radio receiver are respectively

- (a) 0.535 MHz–1.605 MHz and 100 kHz
- (b) 53.5 MHz–160.5 MHz and 10 kHz
- (c) 0.535 MHz–1.605 MHz and 10 kHz
- (d) 53.5 MHz–160.5 MHz and 100 kHz

136. For the same average transmitted or modulated signal power and the same average noise power in the message bandwidth, a coherent SSB receiver will have exactly the same output signal-to-noise ratio as

- (a) a coherent DSB-SC receiver
- (b) an AM receiver
- (c) a VSB receiver
- (d) an SSB receiver

137. Over a certain binary communication channel, the symbol 0 is transmitted with probability 0.4 and 1 is transmitted with probability 0.6. It is given that $p(\epsilon/0) = 10^{-6}$ and $p(\epsilon/1) = 10^{-4}$, where $p(\epsilon/x_i)$ is the probability of detecting the error given that x_i is transmitted. What is the error probability of the channel?

- (a) 0.604×10^{-3}
- (b) 0.604×10^{-5}
- (c) 0.604×10^{-6}
- (d) 0.604×10^{-4}

138. Which one of the following noises arises in electronic devices such as diodes and transistors because of the discrete nature of current flow?

- (a) Shot noise
- (b) Thermal noise
- (c) Gaussian noise
- (d) Random noise

139. Which one of the following represents the output signal-to-noise ratio of a uniform quantizer? (where P denotes average power of the message signal $m(t)$ and R denotes number of bits per sample)

- (a) $\left(\frac{3P}{m_{\max}^2}\right) 2^{2R}$
- (b) $\left(\frac{2P}{m_{\max}^3}\right) 2^{3R}$
- (c) $\left(\frac{3P}{m_{\max}^2}\right) 2^R$
- (d) $\left(\frac{3P}{m_{\max}^2}\right)$

140. Removing the redundant information before encoding is the basic idea behind

- (a) quantization
- (b) delta modulation
- (c) pulse-code modulation
- (d) differential pulse-code modulation

141. Identify the given circuit shown in the figure.

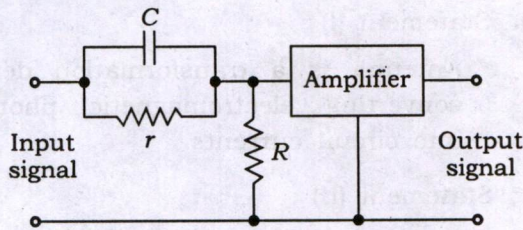

- (a) Band-pass filter
- (b) De-emphasis filter
- (c) Pre-emphasis filter
- (d) Band-reject filter

142. In which one of the following techniques, RF binary signals are transmitted as given?

$$0: \sqrt{2} p'(t) \cos [\omega_c - (\Delta\omega/2)]t$$

$$1: \sqrt{2} p'(t) \cos [\omega_c + (\Delta\omega/2)]t$$

- (a) ASK
- (b) FSK
- (c) PSK
- (d) MPSK

143. Which one of the following statements is **not** correct regarding the features of CDMA?

- (a) Multipath fading may be substantially increased because the signal is spread over a large spectrum.
- (b) Channel data rates are very high in CDMA systems.
- (c) The near-far problem occurs at a CDMA receiver if an undesired user has a high detected power as compared to the desired user.
- (d) Many users of a CDMA system share the same frequency.

144. How many 6 MHz wide TV channels can be multiplexed on 800 MHz coaxial cable?

- (a) 96
- (b) 266
- (c) 133
- (d) 48

Directions :

Each of the next **six (06)** items consists of two statements, one labelled as 'Statement (I)' and the other as 'Statement (II)'. You are to examine these two statements carefully and select the answers to these items using the code given below.

Code :

- (a) Both Statement (I) and Statement (II) are individually true and Statement (II) is the correct explanation of Statement (I)
- (b) Both Statement (I) and Statement (II) are individually true but Statement (II) is **not** the correct explanation of Statement (I)
- (c) Statement (I) is true but Statement (II) is false
- (d) Statement (I) is false but Statement (II) is true

145. Statement (I) :

The magnetization curve is the relationship between air gap flux and the field winding m.m.f. or field winding current.

Statement (II) :

No-load magnetization curve is the graph between armature-generated e.m.f. and field current with constant armature speed.

146. Statement (I) :

Some of the common and familiar polymers are polyethylene (PE), nylon, polyvinyl chloride (PVC), polycarbonate (PC), polystyrene (PS) and silicone rubber.

Statement (II) :

Polymers include the familiar plastic and rubber materials.

147. Statement (I) :

Voltage (or potential difference) is the energy required to move a unit charge through an element.

Statement (II) :

Power is the time rate of expending or absorbing energy.

148. Statement (I) :

A transfer function is a function which relates the current or voltage at one port to the current or voltage at another port.

Statement (II) :

If the function has one or more poles in the right-half plane, then the function is non-minimum phase.

149. Statement (I) :

Antenna is a transformation device converting electromagnetic photons into circuit currents.

Statement (II) :

An antenna converts photons to currents or vice versa.

150. Statement (I) :

Shannon has shown that it is possible to achieve error-free communication by adding sufficient redundancy.

Statement (II) :

The addition of an extra check digit increases redundancy.

SPACE FOR ROUGH WORK

SPACE FOR ROUGH WORK

SPACE FOR ROUGH WORK

SPACE FOR ROUGH WORK

PKL-D-ELX/39A

36

SB22—19788